



**DU5053Z**  
**DU5051Z**  
**DK5153Z**

User Manual

# Table of Contents

<b>1.General Information</b>	<b>5</b>
Copyright.....	5
Disclaimer.....	5
Trademark Recognition.....	5
<b>Important Safety Information.....</b>	<b>6</b>
Symbols used .....	6
General Safety Information.....	6
Symbols used .....	6
<b>Laser Warning.....</b>	<b>7</b>
<b>Warning Labels .....</b>	<b>7</b>
<b>Location of laser aperture.....</b>	<b>8</b>
<b>Notice on laser.....</b>	<b>8</b>
<b>General Notice .....</b>	<b>9</b>
Power Supply .....	9
Cleaning the Projector .....	9
Regulatory Warnings .....	9
Symbol Explanations.....	9
Special Care for Laser Beams! .....	9
Sun Light Warning .....	9
<b>2.Getting Started</b>	<b>10</b>
<b>Package Content .....</b>	<b>10</b>
<b>Projector Features .....</b>	<b>11</b>
<b>Projector Functions .....</b>	<b>12</b>
Control Keypad .....	12
<b>Connect Source Devices.....</b>	<b>13</b>
<b>Remote Controller (SRC) + Function .....</b>	<b>14</b>
Operating Range.....	15
Batteries .....	15
Combo Key Settings.....	15
<b>Installation Guide.....</b>	<b>16</b>
Verify Installation Location .....	16
Cooling Notes .....	16
Installation Notice.....	17
Setup and Projection options .....	17
Mounting the Projector .....	18
Custom Stand Mount Installation compliances .....	18
Projector Start Guide .....	19
1 Connect Power and Source Devices .....	19
2 Power ON/OFF.....	19
3 Select Source Device.....	19
4 Adjust Projector Tilt .....	20
5 Adjust Projector Lens.....	20
Adjusting Projected Image Position Using Lens Shift.....	21
Projection Distance vs. Projection Size.....	23

# Table of Contents

<b>3.On-Screen Display (OSD) Menu Settings</b>	<b>26</b>
<b>OSD Menu Control</b> .....	<b>26</b>
Navigating the OSD .....	26
<b>INPUT Menu</b> .....	<b>27</b>
Auto Source .....	27
HDMI .....	27
3D ((for DU5053Z/DU5051Z series only) .....	28
Signal Power On .....	28
Test Pattern.....	28
<b>PICTURE Menu</b> .....	<b>29</b>
Picture Mode.....	30
Brightness .....	30
Contrast.....	30
Color Manager .....	30
Advanced .....	31
Smooth Picture(for DK5153Z series only).....	31
Picture Mode Reset.....	31
<b>ALIGNMENT Menu</b> .....	<b>32</b>
Aspect Ratio.....	33
Digital Zoom .....	33
Keystone.....	33
4 Corner .....	33
Masking .....	33
Projection .....	33
Screen Setting .....	33
Warping (for DK5153Z series only) .....	34
Edge Blend (for DK5153Z series only).....	34
Alignment Reset.....	34
<b>CONTROL Menu</b> .....	<b>35</b>
Direct Power On.....	36
Light Source .....	36
High Altitude .....	36
IR Control.....	36
Remote ID.....	36
HDBaseT.....	36
Network.....	37
Rental Mode .....	45
<b>SETTINGS Menu</b> .....	<b>46</b>
Eco .....	47
Audio.....	47
Blank Screen Color .....	47
Menu .....	47
Keypad Lock .....	47
Security Lock .....	48
Language.....	48
Environment Status .....	48
Reset All.....	49
<b>INFO Screen</b> .....	<b>49</b>

# Table of Contents

<b>4.Troubleshooting</b>	<b>50</b>
Common Problems and Solutions.....	50
Troubleshooting Tips .....	50
LED Indicator Messages .....	51
Image Problems Q&A .....	52
Light Source Problems.....	52
Remote Control Problems.....	52
Audio Problems.....	53
Having the Projector Serviced .....	53
HDMI Q&A .....	54
<b>5. Specifications</b>	<b>55</b>
Projector Dimensions .....	55
Projector DataSheet.....	56
Projector Timings Table .....	58
<b>6. Regulatory Compliance</b>	<b>60</b>
FCC Warning .....	60
Canada .....	60
Safety Certifications .....	60
Disposal and Recycling .....	60
<b>7. RS-232 Communication</b>	<b>61</b>
Communication parameter setup .....	61
Operation commands.....	61
<b>8. Servies</b>	<b>67</b>

# 1.General Information

## Copyright

This publication, including all photographs, illustrations and software, is protected under international copyright laws, with all rights reserved. Neither this manual, nor any of the material contained herein, may be reproduced without written consent of the author. © Copyright 2024

## Disclaimer

The information in this document is subject to change without notice. The manufacturer makes no representations or warranties with respect to the contents hereof and specifically disclaims any implied warranties of merchantability or fitness for any particular purpose. The manufacturer reserves the right to revise this publication and to make changes from time to time in the content hereof without obligation of the manufacturer to notify any person of such revision or changes.

## Trademark Recognition



Kensington is a U.S. registered trademark of ACCO Brand Corporation with issued registrations and pending applications in other countries throughout the world.



HDMI, the HDMI Logo, and High-Definition Multimedia Interface are trademarks or registered trademarks of HDMI Licensing LLC in the United States and other countries.



HDBaseT™ and the HDBaseT Alliance logo are trademarks of the HDBaseT Alliance.

All other product names used in this manual are the properties of their respective owners and are acknowledged.

## Important Safety Information

**Important:**

It is strongly recommended that you read this section carefully before using the projector. These safety and usage instructions will ensure that you enjoy many years of safe use of the projector. Keep this manual for future reference.

## Symbols used

Warning symbols are used on the unit and in this manual to alert you of hazardous situations. The following styles are used in this manual to alert you to important information.

**Note:**

Provides additional information about the topic.

**Important:**

Provides additional information that should not be overlooked.

**Caution:**

Alerts you to situations that may damage the unit.

**Warning:**

Alerts you to situations that may damage the unit, create a hazardous environment, or cause personal injury.

Throughout this manual, component parts and items in the OSD menus are denoted in bold font as in this example:

“Push the **Menu** button on the remote control to open the **Main menu**.”

## General Safety Information

- Do not open the unit case. There are no user-serviceable parts in the unit. For servicing, contact qualified service personnel.
- Follow all warnings and cautions in this manual and on the unit case.
- To avoid damage to eyes, do not look into the lens when the light source is on.
- Do not place the unit on an unstable surface, cart, or stand.
- Avoid using the system near water, in direct sunlight, or near a heating device.
- Do not place heavy objects such as books or bags on the unit.

## Symbols used

This product is intended for the adults who have the ability to operate this machine.

Please write down your projector model number and serial number and keep the information for maintenance purposes in the future. Should the equipment be lost or stolen, the information could also be used for the police report.

Model number:

Serial number:

# Laser Warning

## Warning Labels

Safety Hazard and Warning information Labels are placed at the following locations:

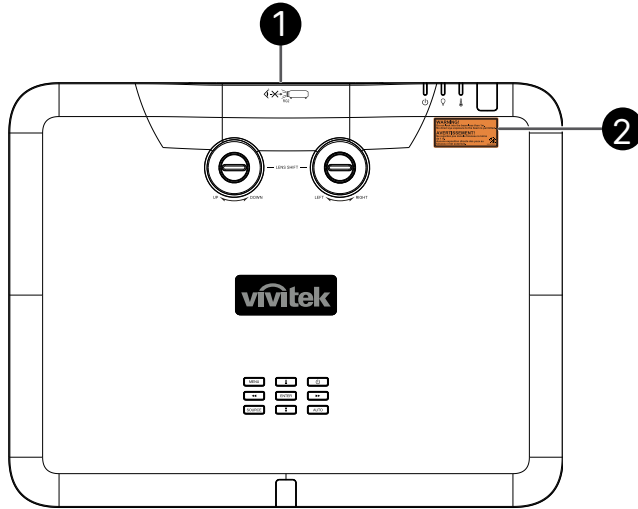

### 1. RG2

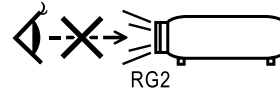

### 2. WARNING LABEL

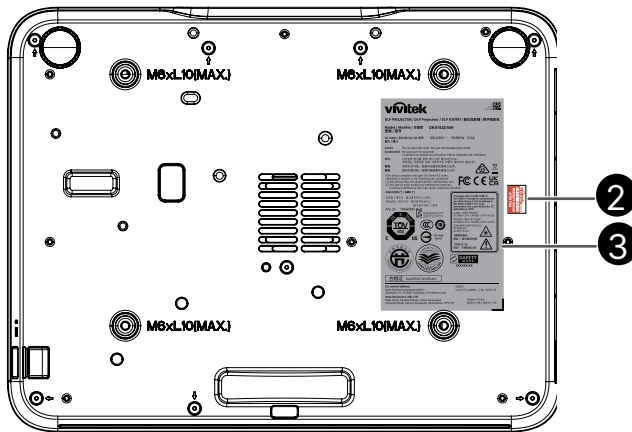

### 3. FDA / ID Label



## Location of laser aperture

The drawing below shows the laser aperture location, do not look directly into the laser aperture whist the projector is turned on.

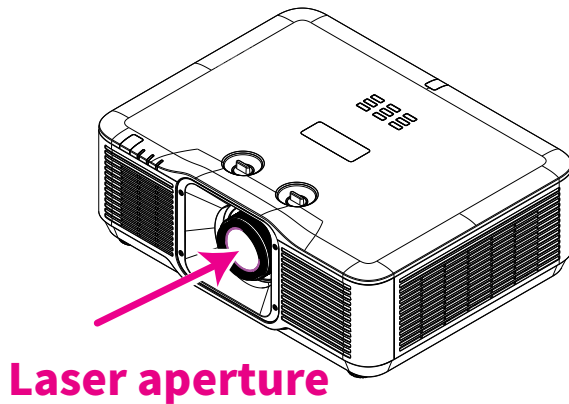

## Notice on laser

Caution – use of controls or adjustments or performance of procedures other than those specified herein may result in hazardous radiation exposure.

Do not point laser or allow laser light to be directed or reflected toward other people or reflective objects.

Direct or scattered light can be hazardous to eyes and skin.

There is a potential hazard of eye exposure to laser radiation if the included instructions are not followed.

Do not allow to look into the projector beam at any distance from the projector. An adult should supervise the children to prevent exposure risks.

Check that there is no one looking at the lens, when using the remote control for starting the projector.

Do not look at the projected light using optical devices(binoculars, telescopes, magnifying glasses, reflectors, etc).

## General Notice

### Power Supply

- Only use the supplied power cord.
- Do not place anything on the power cord. Place the power cord where it will not be in the way of foot traffic.
- Remove the batteries from the remote control when storing or not in use for a prolonged period.

### Cleaning the Projector

- Unplug the power cord before cleaning.
- Allow the light source to cool for about one hour.

### Regulatory Warnings

Before installing and using the projector, read the regulatory notices in the Regulatory Compliance on page [60](#).

### Symbol Explanations



**DISPOSAL:** Do not use household or municipal waste collection services for disposal of electrical and electronic equipment. EU countries require the use of separate recycling collection services.

### Special Care for Laser Beams!

Please pay attention to projector installation with respect to other staging laser light equipment set-up.

These third-party high-power laser light systems can cause permanent damage to the DLP DMD (Digital Micromirror Device) imaging devices used in our projectors.

When using our projectors in environments with any third-party high-power laser systems, avoid direct laser beams pointing towards the projection lens.

This may cause incident light to converge via the projection lens into the projectors optical engine and cause permanent damage to the DLP DMD.

This DLP DMD damage is not covered by our warranty.

### Sun Light Warning

Avoid using the projector in direct sun light. Sun light on the projector lens can severely damage the Digital Mirror Devices (DMD™).

## 2.Getting Started

### Package Content

Carefully unpack the projector and check that the following items are included:

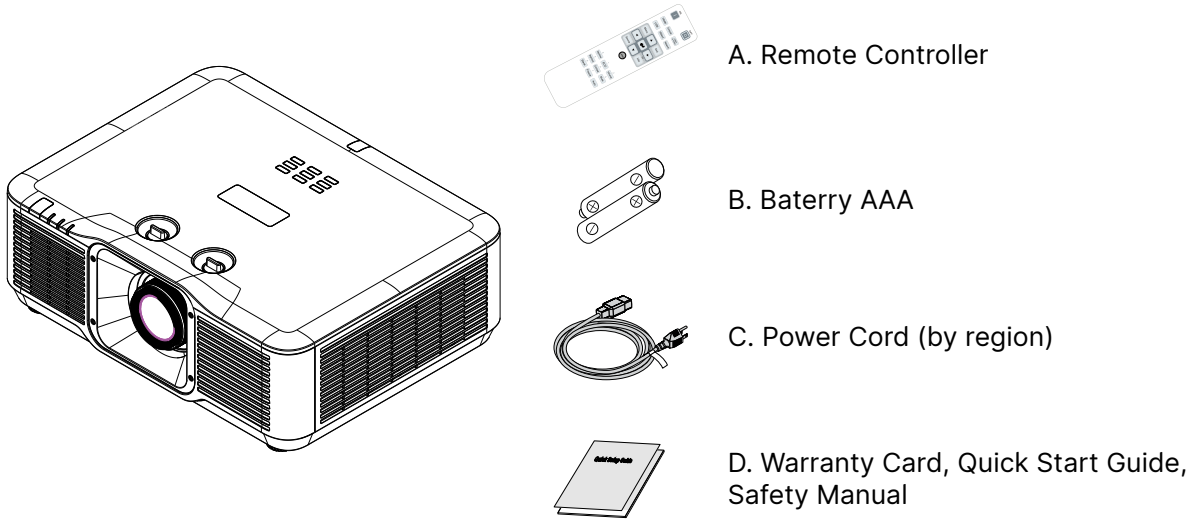

**Note:**

Contact your dealer immediately if any items are missing, appear damaged, or if the unit does not work. It is recommended that you keep the original packing material should you ever need to return the equipment for warranty service.



**Caution:**

Avoid using the projector in dusty environments.

## Projector Features

- Sold state laser phosphor light source for reliable projection and performance.
- Environmentally friendly lamp-less design that is mercury-free and energy efficient.
- DLP® and BrilliantColor™ technologies for high-performance projection.
- Brightness 7,700(for DU5053Z) / 6,300(for DU5051Z) / 6,500(for DK5153Z) lumens with a high 3,000,000:1 contrast ratio for an amazing image quality
- Almost maintenance-free with up to 20,000 hours of operating time.
- Native WUXGA resolution with up to UHD-4K video signal transmission through HDBaseT™(Optional) and HDMI v2.0 interface.
- Native 4K UHD resolution video signal transmission through HDBaseT™(Optional) and HDMI v2.0 interface.(for DK5153Z)
- Manual zoom and focus for easy adjustment and positioning flexibility.
- Distorted and trapezoid image issues are easily corrected with HV keystone and 4-corner adjustments.
- New super powerful warping and edge blending function for various installation environment and immersive scenarios.(for DK5153Z)
- High Dynamic Range (HDR10) enhances picture quality by providing more realistic images with greater contrast and a wider range of colors.
- Display connectivity inputs and outputs including: HDMI v2.0, HDBaseT™(Optional) and HDMI out.
- HDBaseT™ interface with support for distribution of digital HD video content over standard CAT5e/6 LAN cable.
- 3D compatibility with DLP® Link™ and HDMI 2.0 technology support (Blu-ray, side by side, frame packing, top and bottom) for dazzling and realistic life-like images.
- Portrait mode projection allows the projector to be easily setup and installed in a 90° installation & 360° operation and projection design for set up in all angles.
- Airtight sealed optical engine for superior performance against dust and fibre ingress combined with a filter-less air-cooling design.
- Optimized system layout with high efficiency cooling system.
- 24/7 continuous operation.
- Network ready for integration and system administration via RJ45.
- Remotely monitor and manage a location's networked projectors from a centralized PC using Digital Projection's free "Projector Controller II" application for Windows OS.
- Usage time & power level locked provide convenient settings for rental market.
- Suitable for Golf simulation commercial market via TR 0.8~1.2 lenses.(for DK5153Z)

## Projector Functions

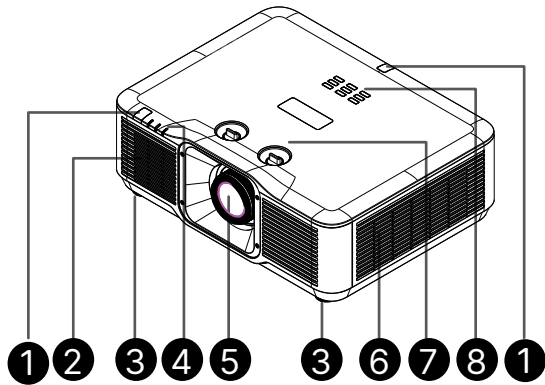

1. IR Receiver
2. Air Vents (inlet)
3. Tilt Foot
4. LED Indicator
5. LENS
6. Air Vents (outlet)
7. LENS SHIFT
8. Control Keypad

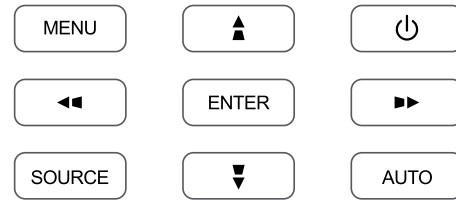

### Control Keypad

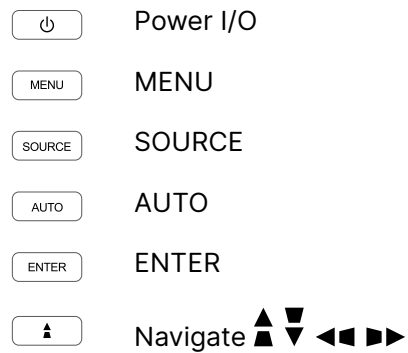

**Important:**

Ventilation openings on the projector allow for good air circulation, which keeps the projector light source cool. Do not obstruct any of the ventilation openings.

## Connect Source Devices

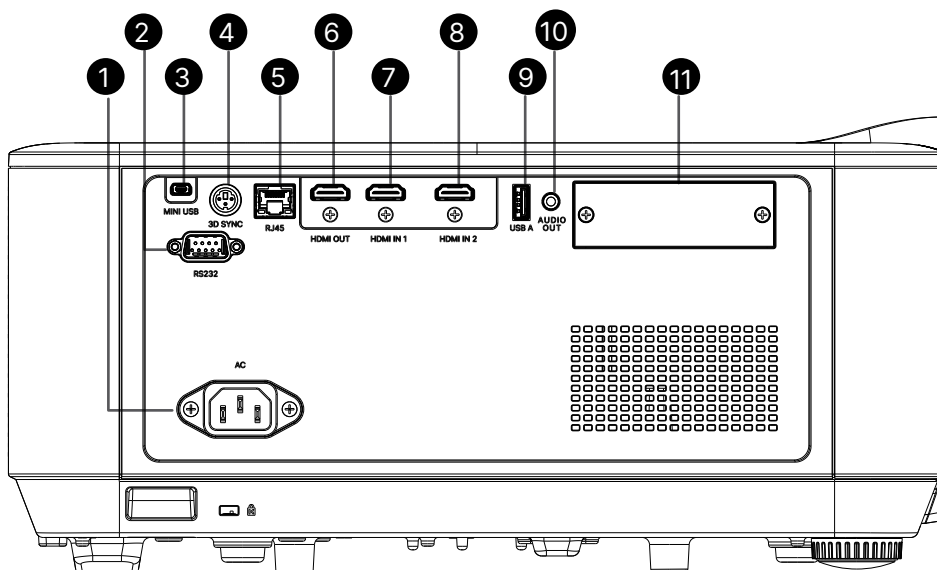

- 1. AC IN
- 2. RS232
- 3. MINI USB
- 4. 3D-SYNC  
( for DU5053Z/DU5051Z series only )
- 5. RJ45
- 6. HDMI OUT
- 7. HDMI IN 1
- 8. HDMI IN 2
- 9. USB A
- 10. AUDIO OUT
- 11. SDM module slot
  - DHS-01 (HDBaseT SDM): RJ45, USB A 1.5A
  - DWS-01 (WiFi SDM): USB A 1.5A

### DHS-01 (HDBaseT SDM)

Resolution Support	Up to 4K@30Hz, HDR
Transmission Distance	Up to 100 meters (328 feet)
Cable Type	CAT5e/6/6a/7
Audio Support	7.1 Surround Sound, PCM, Dolby Digital
Latency	< 1 ms



### DWS-01 (WiFi SDM)

DRAM	DDR3 256MB
WiFi	IEEE 802.11ac 2.4GHz/5GHz
Support OS	Android/iOS/Windows/macOS/ChromeOS
Power	DC 5V/1A



**Note:**

- To use any feature, you must plug in the connector / SDM module before applying power to the projector.
- Screen controllers are supplied and supported by screen manufacturers.
- Do not use the projectors connectors for anything other than their intended use.
- 

**Warning:**  
 As a safety precaution, disconnect all power to the projector and connecting devices before making connections.

## Remote Controller (SRC) + Function

1. IR Transmitter
2. Laser Pointer
3. Power ON
4. Power OFF

### Connectivity

5. HDMI (Toggle HDMI 1/2 )
6. Computer
7. USB (Not supported)
8. Video / S-Video (Not supported)
9. HDBaseT (SDM module) referring to the "SDM module slot" on page 13
10. Network

### Functions

11. Menu
12. Source
13. Exit
14. Info / ID
15. Navigation
16. Laser Pointer

### Settings

17. ECO / ID 1
18. Keystone / ID 0
19. Brightness / ID 3
20. Blank / ID 6
21. Contrast / ID 4
22. Freeze / ID 7
23. Volume / ID 2
24. Mute / ID 5
25. Auto

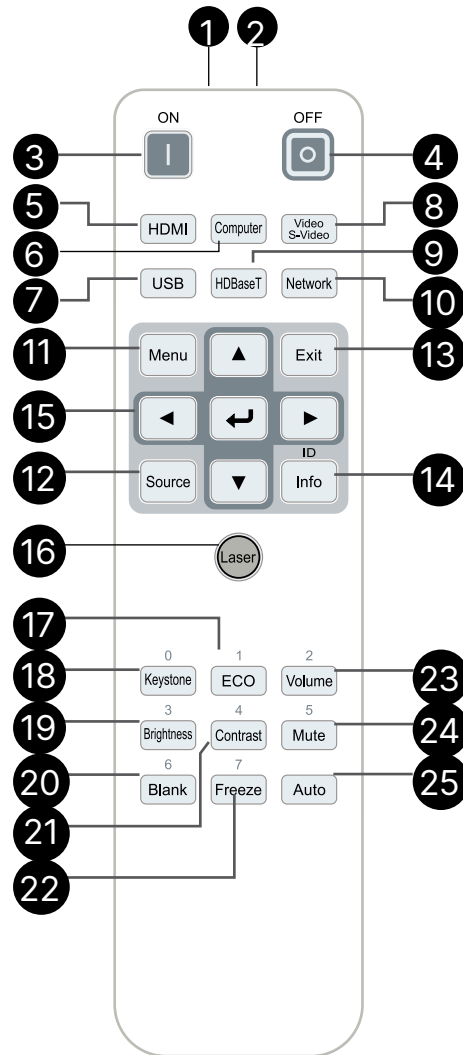

**Important:**

1. Avoid using the projector with bright fluorescent lighting turned on. Certain high-frequency fluorescent lights can disrupt remote control operation.

2. Be sure nothing obstructs the path between the remote control and the projector. If the path between the remote control and the projector is obstructed, you can bounce the signal off certain reflective surfaces such as projector screens.

3. The buttons and keys on the projector have the same functions as the corresponding buttons on the remote control. This user's manual describes the functions based on the remote control.

**Note:**

Complies with FDA performance standards for laser products except for deviations pursuant to Laser Notice No. 50, dated June 24, 2007



**Caution:**

Use of controls, adjustments or performance of procedures other than those specified herein may result in hazardous laser light exposure.

## Operating Range

- The Remote Controller uses infrared transmission to control the projector.
- It is not necessary to point the remote directly at the projector.
- The Remote Controller will function properly within a distance radius of about 7 meters (23 feet) and vertical angle of 15 degrees above or below the projector level.

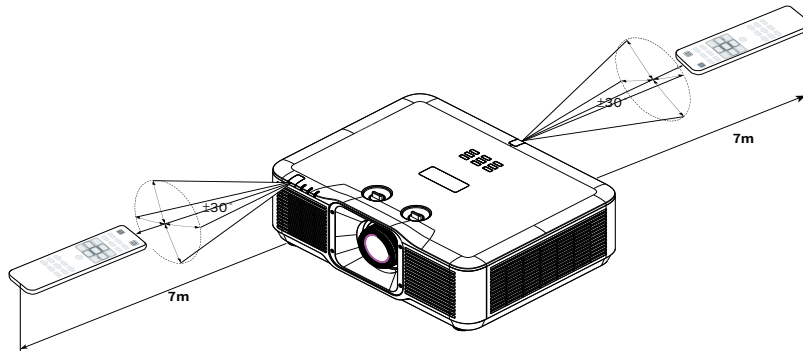

### Note:

If the projector does not respond to the Remote Controller, Move to a closer range or Replace batteries.

## Batteries

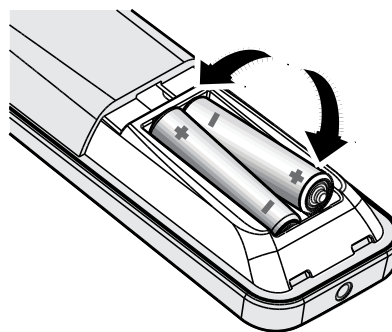
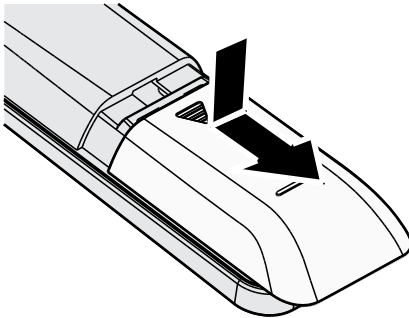

- Slide IN/OUT the battery compartment cover.
- Insert the battery with the positive side facing up.



### Caution:

1. Only use AAA batteries (Alkaline batteries are recommended).
2. Dispose of used batteries according to local ordinance regulations.
3. Remove the batteries when not using the projector for prolonged periods.

## Combo Key Settings

ID+0: Reset Remote Controller customer code to default settings.

ID+(1~7): Set Remote Controller customer code to "1~7".

## Installation Guide

### Verify Installation Location

- To supply power, use the 3-blade (with earthing lead) socket to ensure proper grounding and equalized ground potential for all Projector System equipments.
- Use the power cord provided with the Projector. In case the item is missing, use a qualified 3-blade (with earthing lead) power cord; DO NOT USE 2-BLADE POWER CORD.
- Verify that the voltage is stable, grounded properly and there is no electricity leakage.
- Measure the total power consumption and ensure it is within the safety capacity to avoid safety issue and short circuit.
- Turn on Altitude Mode when located in high altitude areas
- The projector can be installed and will function properly without limitation at any angle or orientation.
- Ensure installation brackets are firmly secured and can support the projector weight
- Avoid installing near air conditioner duct or sub-woofer.
- Avoid installing in locations with high temperature, insufficient cooling and heavy dust.
- Keep away from fluorescent lamps (>1 Meter) to avoid malfunction caused by IR interference
- Before you Power ON, ensure power cord and signal cable are connected properly. To avoid damaging the projector while starting and operating, DO NOT insert or remove the signal cable or the power cord.

### Cooling Notes

#### Air Outlet

- Make sure the air outlet is 50cm clear of any obstruction to ensure proper cooling.
- A hot air outlet of one projector should not be located as to pass the hot air in front of a lens of another projector, this is to avoid the optical phenomenon of thermal distortion of the projected image of the second projector.
- Keep the outlet at least 100cm away from the inlets of other projectors
- The projector generates a massive amount of heat during use. The internal fan dissipates the heat of the projector when shutting down, and such process may continue for a certain period. After the project enters STANDBY MODE status, press the power button to turn off the projector and remove the power cord. DO NOT remove the power cord during the shut-down process, as it may cause damage to the projector. In the meantime, the delayed heat radiating will also affect the service life of the projector. The shut-down process may vary depending on the model used. Whatever the case may be, make sure to disconnect the power cord till after the projector enters the STANDBY status.

#### Air Inlet

- Make sure there is no object blocking air input within 30 cm.
- Keep the inlet away from other heat sources
- Avoided heavy dust area

### Installation Notice

- There is no limitation angle for projector installation

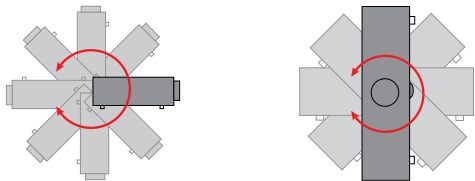

- Insure a minimum clearance space of > 500mm (19.7 inch) around all exhaust vents.

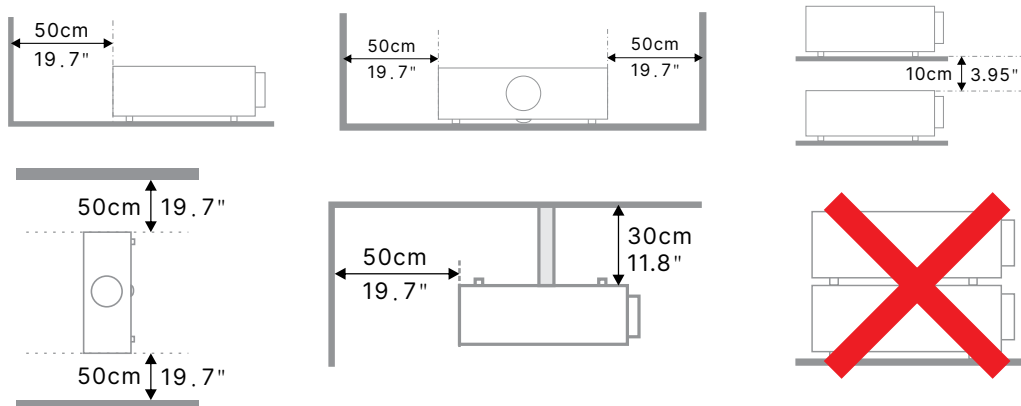

- When operating the projector in an enclosed space, ensure that the surrounding air temperature does not exceed the maximum allowed operating temperature and that all air intake and exhaust vents are unobstructed.

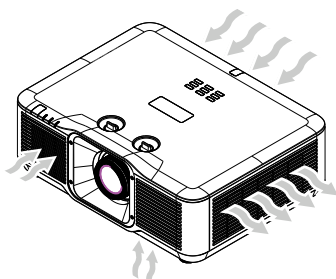

- Ensure that the intake vents do not recycle hot air or exhaust air from the exhaust vents as this may cause the device to shut-down even if the enclosure temperature is within the acceptable operating temperature range.
- All enclosures should pass a certified thermal evaluation to ensure that the projector does not recycle exhaust air.

### Setup and Projection options

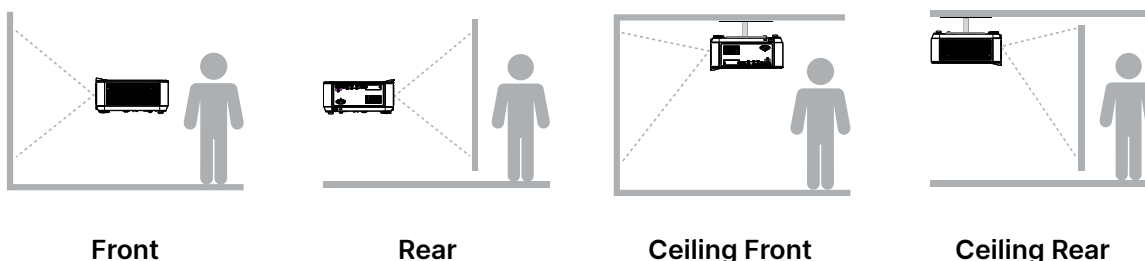

Front

Rear

Ceiling Front

Ceiling Rear

## Mounting the Projector

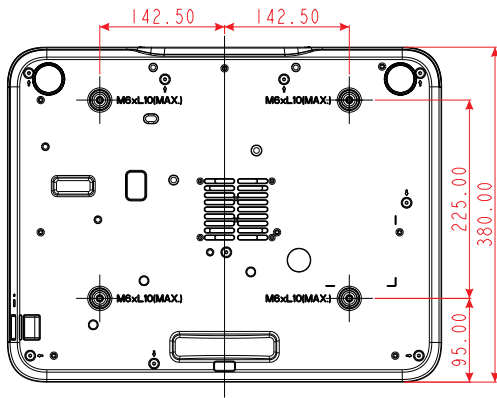

**Caution:** When installing, ensure that you use only UL Listed ceiling mounts.

For ceiling installations, use approved mounting hardware and M6 screws with a maximum screw depth of 10mm (0.39 inch).

The construction of the ceiling mount must be of a suitable shape and strength. The ceiling mount load capacity must exceed the weight of the installed equipment, and as an additional precaution be capable of withstanding three times the weight of the equipment over a period of 60 seconds.

## Custom Stand Mount Installation compliances

For custom design mount installation such as portait, Please comply to the following :

- Use 4 screws to securely anchor the projector to the mount.
- Screw hole center dimension: 225 × 285 (pitch = 142.5) mm
- Ensure a sturdy base design to support the projector weight and avoid toppling over.

**Note:**

The drawing showing below is for referal only. It is not an accurate stand design drawing.

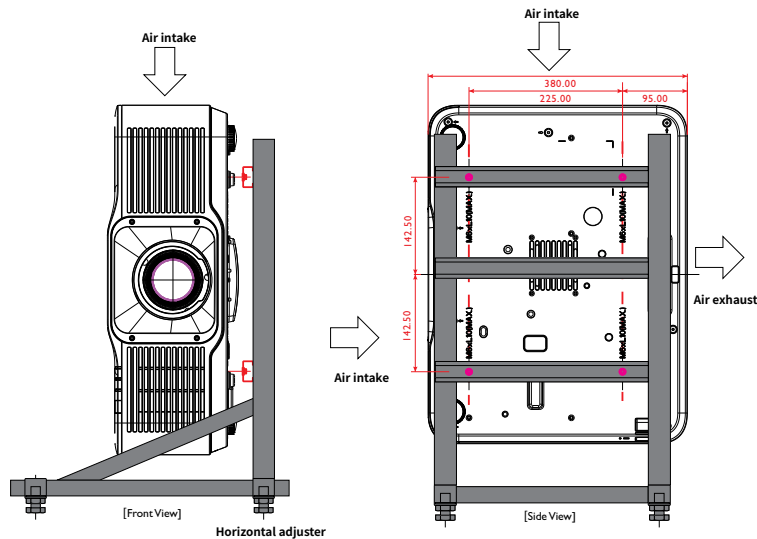

# Projector Start Guide

## 1 Connect Power and Source Devices

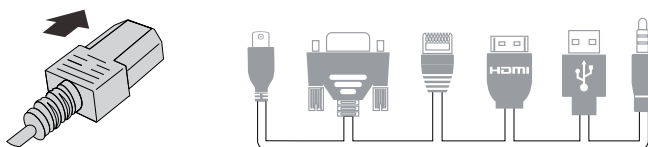
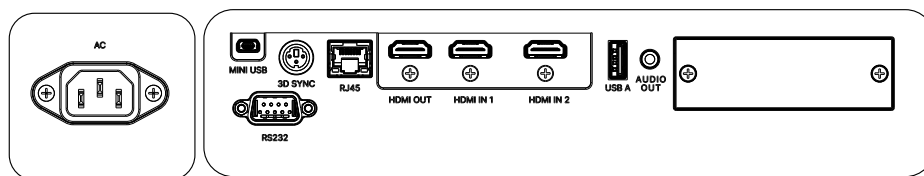

- Securely connect the provided power cord and your Source Devices. (HDMI, USB, RJ45, RS232, etc.)  
When connected, the power led will flash green to solid green.

## 2 Power ON/OFF

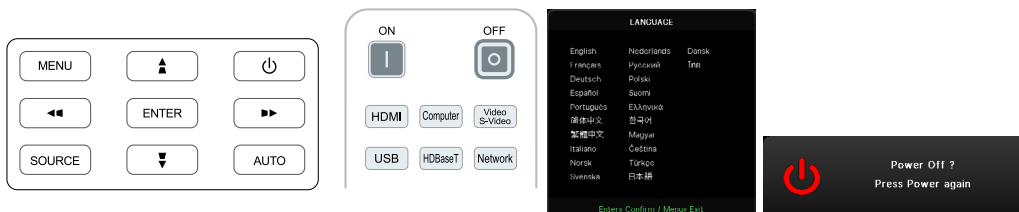

- Turn ON: Press on the projector or **ON** the remote controller. The PWR LED will now flash green. The startup screen will display in approximately 30 seconds.
- The first time you Turn ON the projector, you can select your preferred language. see Setting Language on page 48.
- Turn OFF: Press on the projector or **OFF** on the remote controller. The message "Power Off? /Press Power again" will appears on-Screen Press the POWER button again to confirm the projector Turn OFF.

## 3 Select Source Device

- Press the **SOURCE** button and use to scroll through the Source Devices.
- Press to select the Source Device.

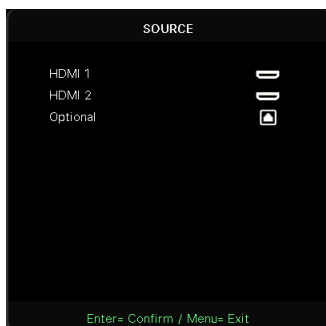



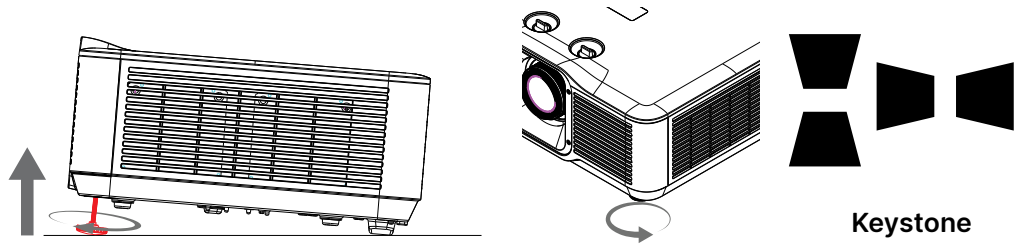

**Note:**

When using the optional DHS-01 (HDBaseT SDM) module, the projector supports an HDBaseT connection with distances up to 100m/328ft when using a single CAT5e (or above) cable.

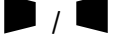
# 4 Adjust Projector Tilt

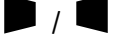

- To Raise the Tilt angle, Rotate counter clockwise both Left and Right Tilt foot.
- Press KEYSTONE button to adjust the Screen Tilt. The Keystone control appears on the display. Press  /  for V Keystone correcting image. Press  /  for H Keystone correcting image.

-  **Caution:** When setting up the projector
1. The projector table or stand should be level and sturdy.
  2. Position the projector so that it is perpendicular to the screen.
  3. Ensure the cables are in a safe location. You could trip over them.

# 5 Adjust Projector Lens

## ZOOM

Rotate the Image-zoom control inner ring to resize the projected image and screen size.

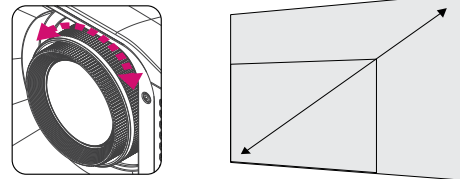

## FOCUS

Rotate the Image-focus control outer ring to sharpen the projected image.

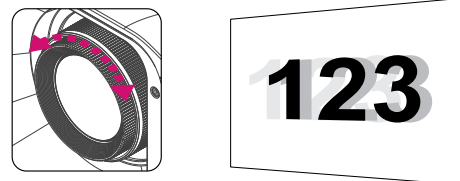

## SHIFT

The Lens Shift feature provides a lens shift function that can be used to adjust the position of the projected image either horizontally or vertically.

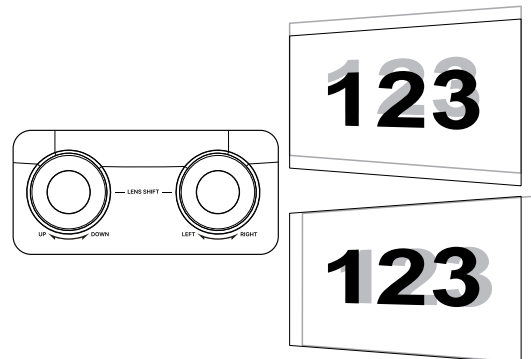

**Note:**

Shift is a unique system that provides lens shift while maintaining a much higher ANSI contrast ratio than traditional lens shift systems.

Do not rotate the lens shift knobs further than the first click sound, this is the shift limit. To reverse shift from this point, lightly press down on the knob to rotate in the opposite direction.

To view the Shift Range diagram and further clarification see page 21.

## Adjusting Projected Image Position Using Lens Shift

### DU5053Z / DU5051Z

#### STD Lens(TR1.15~TR1.9)/Semi-ST Lens (TR0.8~TR1.2)

The projector has the lens shift feature; the image can be shifted vertically or horizontally without moving the projector. The lens shift range is shown in the percentage of the image height and width, the maximum vertical shift range can be up to 15% of the image height and down to 5% of the image height, and maximum horizontal shift range is 2% of the image width to right and left. Please refer to below illustration.

#### Lens Shift Range Diagram

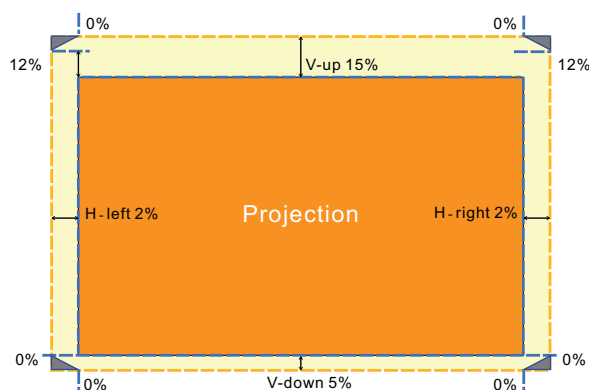

The yellow area is the Boundary of Lens Shift

#### ST Lens(TR0.5)

The projector has the lens shift feature; the image can be shifted vertically or horizontally without moving the projector. The lens shift range is shown in the percentage of the image height and width, the maximum vertical shift range can be up to 9% of the image height and down to 5% of the image height, and maximum horizontal shift range is 2% of the image width to right and left. Please refer to below illustration.

#### Lens Shift Range Diagram

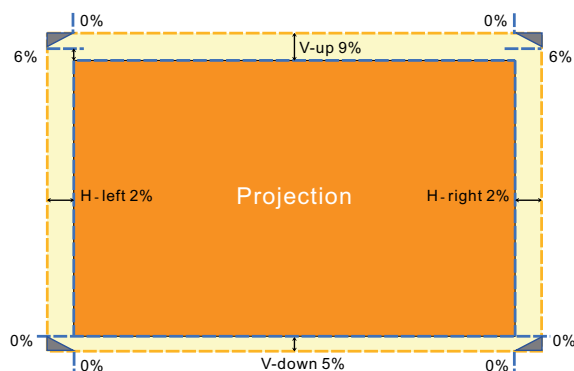

The yellow area is the Boundary of Lens Shift

**DK5153Z**

**STD Lens(TR1.15~TR1.9)/Semi-ST Lens (TR0.8~TR1.2)**

The projector has the lens shift feature; the image can be shifted vertically or horizontally without moving the projector. The lens shift range is shown in the percentage of the image height and width, the maximum vertical shift range can be up to 22% of the image height and down to 2% of the image height, and maximum horizontal shift range is 2% of the image width to right and left. Please refer to below illustration.

**Lens Shift Range Diagram**

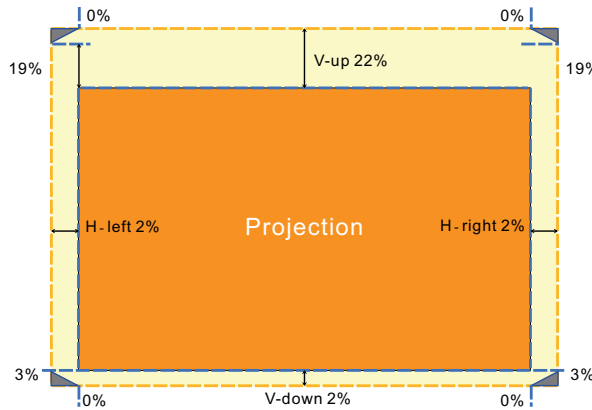

The    area is the Boundary of Lens Shift

**ST Lens(TR0.5)**

The projector has the lens shift feature; the image can be shifted vertically or horizontally without moving the projector. The lens shift range is shown in the percentage of the image height and width, the maximum vertical shift range can be up to 21% of the image height and down to 2% of the image height, and maximum horizontal shift range is 2% of the image width to right and left. Please refer to below illustration.

**Lens Shift Range Diagram**

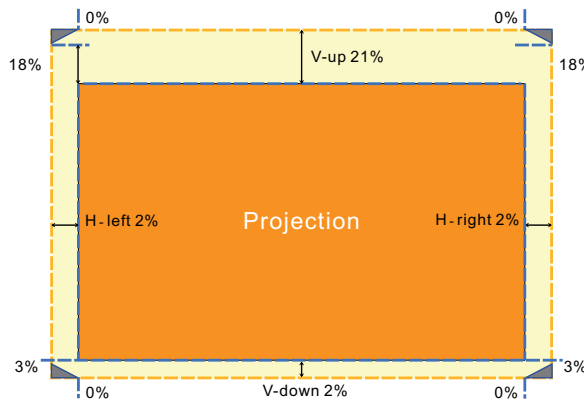

The    area is the Boundary of Lens Shift

### Projection Distance vs. Projection Size

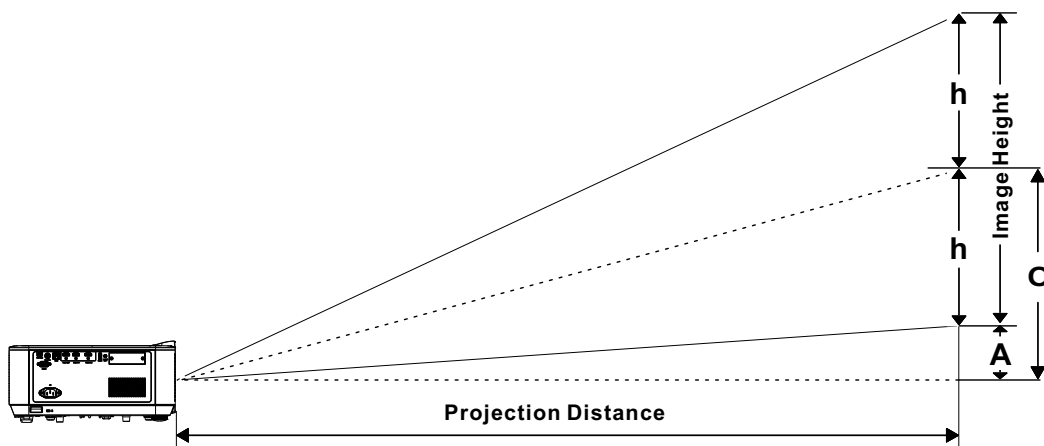

Projection Distance and Size Table

DU5053Z/DU5051Z

Standard projection lens:

TR: 1.15 ~ 1.9; offset=115%; TR: +/- 2%; Lens Shift: +/- 2%

	Tele				Wide			
Distance(m)	1.48	3.30	4.14	6.29	1.48	1.99	5.03	6.29
Diagonal(")	36.40	80.00	100.00	151.70	60.00	80.00	200.00	250.00
Image Width (mm)	784.0	1723.1	2153.9	3267.5	1292.3	1723.1	4307.8	5384.8
Image Height (mm)	490.0	1077.0	1346.2	2042.2	807.7	1077.0	2692.4	3365.5
h(mm)	245.0	538.5	673.1	1021.1	403.9	538.5	1346.2	1682.7
O (mm)	318.5	700.0	875.0	1327.4	525.0	700.0	1750.1	2187.6
A (mm)	73.5	161.5	201.9	306.3	121.2	161.5	403.9	504.8

Short Throw Zoom projection lens:

TR: 0.801 ~ 1.202; offset=122%; TR: +/- 3%; Lens Shift: +/- 2%

	Tele				Wide			
Distance(m)	1.37	2.61	3.94	5.25	1.37	1.73	3.49	5.25
Diagonal(")	53.30	100.00	150.00	199.70	80.00	100.00	200.00	300.00
Image Width (mm)	1148.0	2153.9	3230.9	4301.4	1723.1	2153.9	4307.8	6461.7
Image Height (mm)	717.5	1346.2	2019.3	2688.4	1077.0	1346.2	2692.4	4038.6
h(mm)	358.8	673.1	1009.6	1344.2	538.5	673.1	1346.2	2019.3
O (mm)	466.4	875.0	1312.5	1747.4	700.0	875.0	1750.1	2625.1
A (mm)	107.6	201.9	302.9	403.3	161.5	201.9	403.9	605.8

Short throw projection lens:

TR: 0.505; offset=109%;TR : +/- 3%; Lens Shift : +/- 2%

	Fix			
Distance(m)	0.97	1.08	1.20	1.76
Diagonal(")	90.00	100.00	110.00	160.00
Image Width (mm)	1938.5	2153.9	2369.3	3446.3
Image Height (mm)	1211.6	1346.2	1480.8	2153.9
h(mm)	605.8	673.1	740.4	1077.0
O (mm)	714.8	794.3	873.7	1270.8
A (mm)	109.0	121.2	133.3	193.9

Offset % =  $(O+h) / (2 \times h) \times 100\%$

$O = A + h$

$h = (1/2) \times (\text{image height})$

DK5153Z

Standard projection lens:

TR: 1.15 ~ 1.9; offset=122%; TR: +/- 2%; Lens Shift: +/- 2%

	Tele				Wide			
Distance(m)	1.51	3.38	4.23	6.43	1.52	2.03	5.14	6.43
Diagonal(")	36.30	80.00	100.00	151.50	60.00	80.00	200.00	250.00
Image Width (mm)	803.6	1771.0	2213.8	3353.9	1328.3	1771.0	4427.6	5534.5
Image Height (mm)	452.0	996.2	1245.3	1886.6	747.2	996.2	2490.5	3113.2
h(mm)	226.0	498.1	622.6	943.3	373.6	498.1	1245.3	1556.6
O (mm)	325.5	717.3	896.6	1358.3	538.0	717.3	1793.2	2241.5
A (mm)	99.4	219.2	274.0	415.0	164.4	219.2	547.9	684.9

Short Throw Zoom projection lens:

TR: 0.801 ~ 1.202; offset=122%; TR: +/- 3 %; Lens Shift: +/- 2%

	Tele				Wide			
Distance(m)	1.41	2.68	5.41	5.40	1.41	1.77	3.59	5.40
Diagonal(")	53.30	100.00	200.00	199.80	80.00	100.00	200.00	300.00
Image Width (mm)	1180.0	2213.8	4427.6	4423.2	1771.0	2213.8	4427.6	6641.4
Image Height (mm)	663.7	1245.3	2490.5	2488.0	996.2	1245.3	2490.5	3735.8
h(mm)	331.9	622.6	1245.3	1244.0	498.1	622.6	1245.3	1867.9
O (mm)	477.9	896.6	1793.2	1791.4	717.3	896.6	1793.2	2689.8
A (mm)	146.0	274.0	547.9	547.4	219.2	274.0	547.9	821.9

Short throw projection lens:

TR: 0.504; offset=121%; TR: +/- 3 %; Lens Shift: +/- 2%

	Fix			
Distance(m)	1.00	1.11	1.23	1.80
Diagonal(")	90.00	100.00	110.00	160.00
Image Width (mm)	1992.4	2213.8	2435.2	3542.1
Image Height (mm)	1120.7	1245.3	1369.8	1992.4
h(mm)	560.4	622.6	684.9	996.2
O (mm)	795.7	884.1	972.6	1414.6
A (mm)	235.4	261.5	287.7	418.4

Offset % = (O+h) / (2xh) x 100%

O = A + h

h = (1/2) x (image height)

## 3.On-Screen Display (OSD) Menu Settings

### OSD Menu Control

The On-Screen Display (OSD) lets you make image adjustments, change various settings and check the projector's current status.

### Navigating the OSD

You can use the remote control or the control buttons on the projector to navigate and make changes to the OSD.

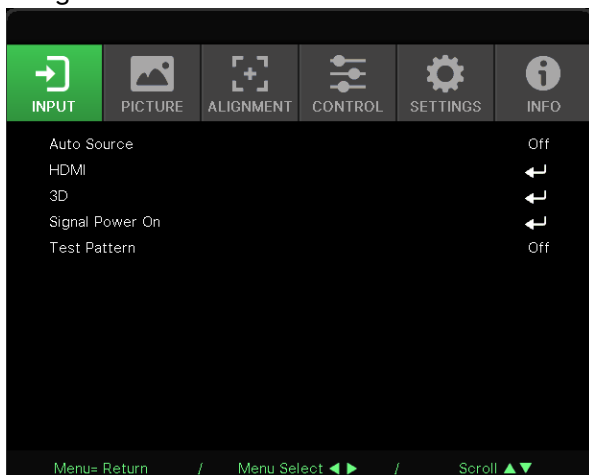

- To enter the OSD, press the MENU button.
- There are six top menus icons. Press ◀ / ▶ buttons to select menus.
- Press ▼/▲ buttons to scroll through the submenus.
- Press ◀ / ▶ buttons to change the submenus settings.
- Press ↵ to enter the advanced submenus settings
- Press the MENU button to close the OSD or leave a submenu.
- Press the EXIT button to return to the previous menu.

**Note:**

Depending on the video source, not all items in the OSD are available. Items that are not available cannot be accessed and are grayed out.

## INPUT Menu

Auto Source	On, Off
HDMI	HDMI Format: Auto, RGB Limited, RGB Full, YUV Limited, YUV Full
	HDR: Auto, Off, HDR 10
	HDMI EDID: HDMI1, HDMI2
3D	3D: DLP-Link, IR
	3D Sync Invert: Off, On
	3D Format: Auto, Top, Bottom, Frame Sequential, Frame Packing, Side By Side, Off
	3D Sync Out Delay: 0 ~ 359

(for DU5053Z/DU5051Z series only)

Signal Power On	HDMI: Off, On
Test Pattern	Grid, White, Red, Green, Blue, Black, RGB Ramps, Color Bar, Step Bar, CheckBoard, Horizontal Lines, Vertical Lines, Diagonal Lines, Horizontal Ramps, Vertical Ramps, Off

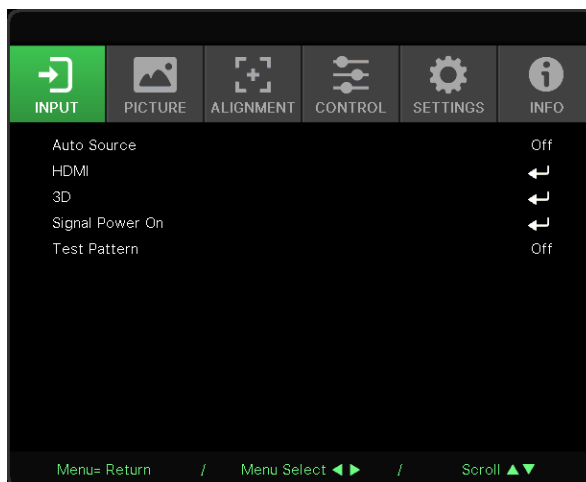



### Auto Source

- Use ◀/▶ to set On/Off.
- **On:** Lets projector searching for the input signal automatically.
- **Off:** Select the input signal manually.

### HDMI













- Press ↵ and use ▼/▲ to scroll through submenus.
- **HDMI Format:** Set HDMI Format.  
 Auto: According to HDMI Info Frame to detect color space automatically.  
 RGB Limited: Force to select RGB limited range color space.  
 RGB Full: Force to select RGB full range color space.  
 YUV Limited: Force to select YUV limited range color space.  
 YUV Full: Force to select YUV full range color space
- **HDR:** Use ◀/▶ to set Auto, Off, HDR 10.  
 Auto: Switch to HDR setting automatically when detecting HDR sync.  
 Off: No matter detect HDR sync or not , force to close HDR settings .  
 HDR 10: No matter detect HDR sync or not , force to select HDR settings

- **HDMI EDID:** Press  and use / to set HDMI1, HDMI2  
Enhanced: Select to use HDMI 2.0 EDID.  
Standard: Select to use HDMI 1.4b EDID.

**Caution:**

For the DU5053Z/DU5051Z (WUXGA) series, when the HDMI Out is connected, it is recommended to change the HDMI EDID setting to Standard (HDMI 1.4b).

### 3D ((for DU5053Z/DU5051Z series only))

- Press  and use / to set 3D source, sync method and 3D format.
- Before performing 3D setting, make sure that the input signal with 3D sync is connected.
- **3D:** Use / to enable or disable 3D functions.  
DLP-Link: Enable internal 3D sync.  
IR: Enable external 3D sync.
- **3D Sync Invert:** Use / to swap the 3D signal L/R or R/L.  
On: Enable inverse signal.  
Off: Follow received signal sync.
- **3D Format:** Press  and use / to select 3D format type :  
Auto, Top, Bottom, Frame Sequential, Frame Packing, Side By Side, Off.
- **3D Sync Out Delay:** Use / to adjust delay the output 3D sync.

**Note:**

3D feature is only supported by DU5053Z/DU5051Z.

**Important:**

People with the following conditions should view 3D image with great care:

Children under six years in age.

People who are sensitive to light or allergic to light, unhealthy and have a history of cardiovascular diseases.

People who are tired or lack of sleep.

People who are under the impact of drugs or alcohol.





Normally, it is safe to watch 3D images. However, some people might feel uncomfortable. Refer to the guidelines that were revised and released by the 3D Consortium on October 31<sup>st</sup> 2011. It states that those who watch 3D images, need to take a break for at least 5 to 15 minutes every thirty minutes or one hour.

**Note:**



The copyright of this material belongs to the 3D Consortium. All rights reserved.

See this link for more information: [http://www.3dc.gr.jp/english/scmt\\_wg\\_rep/index.html](http://www.3dc.gr.jp/english/scmt_wg_rep/index.html)

### Signal Power On

- Press  and use / to scroll through submenus.
- **HDMI:** Use / to set On/Off to enable or disable auto Power On by HDMI input.

### Test Pattern

- Use / to select Grid, White, Red, Green, Blue, Black, RGB Ramps, Color Bar, Step Bar, CheckBoard, Horizontal Lines, Vertical Lines, Diagonal Lines, Horizontal Ramps, Vertical Ramps, Off to enable the test pattern image.

# PICTURE Menu

Picture Mode	Presentation, Bright, Game, Movie, Golf, Blending, sRGB, DICOM SIM, User, (3D ), (HDR 10)
Brightness	0~100
Contrast	0~100
Color Manager	Color: R, G, B, C, M, Y, W Hue: -99~99 Red : 0~399 (only W) Saturation: 0~199 Green : 0~399 (only W) Gain: 5~195 Blue : 0~399 (only W)
Advanced	Brilliant Color: 0~10 Sharpness: 0~31 Gamma: 1.8, 2.0, 2.2, 2.4, B&W, Linear, DICOM SIM HDR PQ: PQ-L300, PQ-L400, PQ-L500 (for HDR only) Color Temperature: Warm, Normal, Cold Input Balance: R Gain, G Gain, B Gain, R Offset, G Offset, B Offset
Smooth Picture	Auto, On, Off
<b>(for DK5153Z series only)</b>	
Picture Mode Reset	Current: (OK, Cancel) All: (OK, Cancel)

DU5053Z / DU5051Z

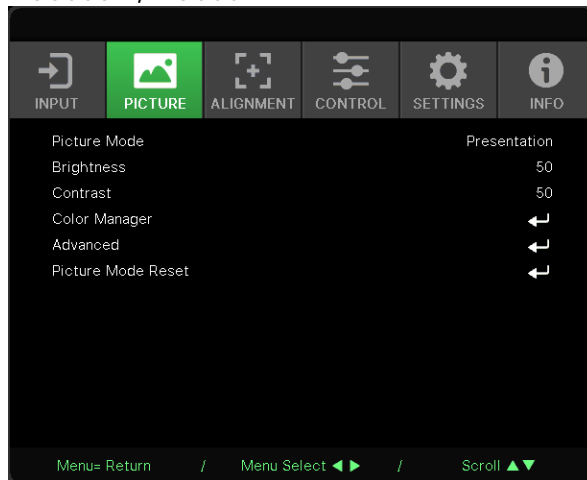

DK5153Z

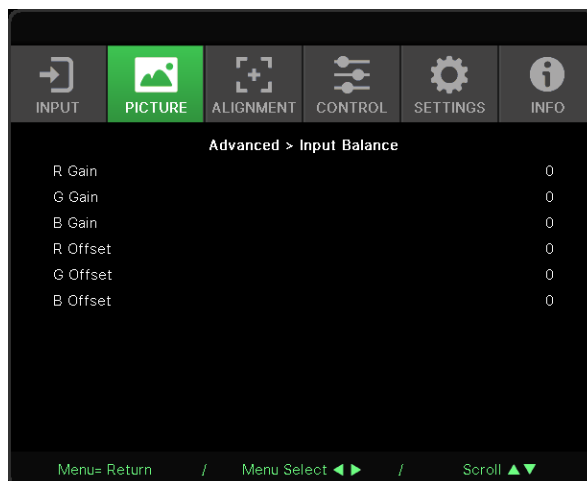
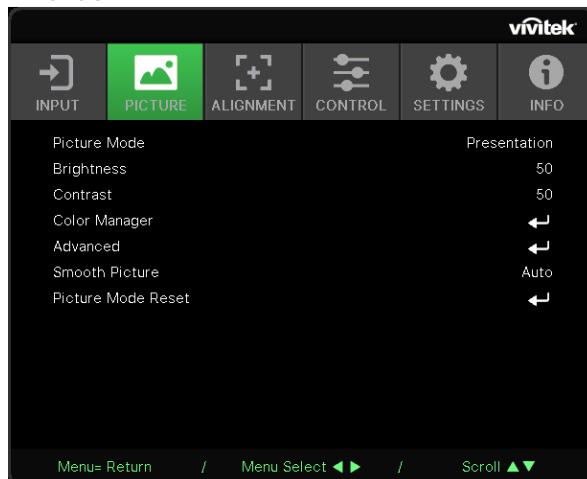

## Picture Mode

- Use ◀/▶ to select a mode according to personal preference.
- **Presentation:** Suggest to use. The best projection effect for presentation.
- **Bright:** The mode is suitable for the application environment where is needed with highest brightness output .
- **Game:** Using for video game.
- **Movie:** To provide good balance of color saturation, contrast and brightness. Suggest to use in a dark environment.
- **Golf:** To provide Golf colors.
- **Blending:** The mode is suitable for immersive environment.
- **sRGB:** Optimization RGB colors to reach true-to-life images with limited brightness setting.
- **DICOM SIM:** To use for Digital Imaging and Communications in Medicine.
- **User:** Personalization with preference of Brightness, Contrast, Color.
- **3D:** Automatically switch when detecting 3D sync.  
**Note:**3D feature is only supported by DU5053Z/DU5051Z.
- **HDR 10:** Automatically switch when detecting HDR sync.

## Brightness

- Use ◀/▶ to increase or decrease the brightness level of the image.



















## Contrast

- Use ◀/▶ to adjust the contrast level of the image.



## Color Manager

- Press ↵ and use ▼/▲ to scroll through submenus.
- **Color:**To select and adjust the color(Red,Green,Blue,Cyan,Magenta,Yellow, White).
- **Hue:** Use ◀/▶ to adjust the Color Hue value.
- **Saturation:** Use ◀/▶ to adjust the Color Saturation value.
- **Gain:** Use ◀/▶ to adjust the Color Gain value.
- **Red:**Use ◀/▶ to adjust the White Color's Red value.
- **Green:**Use ◀/▶ to adjust the White Color's Green value.
- **Blue:**Use ◀/▶ to adjust the White Color's Blue value.
- These three options are used to adjust the range of color input for the entire image. If minimal amount of red, green or blue appears in the gray areas, lower the gain of the corresponding color accordingly. As gain increases, the contrast of the image will become lower.





## Advanced

- Press  and use / to scroll through submenus.
- **Brilliant Color:** Use / to adjust the brilliant color of image.
- **Sharpness:** Use / to adjust the sharpness of image.
- **Gamma:** Use / to select the different chrominance of image.  
When the ambient light is so bright that may affect the projection image in the dim area. , you can change the gamma to adjust the chrominance. The available options are 1.8, 2.0, 2.2, 2.4, B&W, Linear, DICOM SIM.
- **HDR PQ:** Use / to select PQ settings PQ-L300, PQ-L400, PQ-L500.
- **Color Temperature:** Use / to select the color temperature.  
Warm : Make image reddish white.  
Normal : Normal colorings of white.  
Cold : Make image bluish white.
- **Input Balance:** Press  and use / to scroll through submenus.  
Use / to adjust Gain and Offset values of Red ,Green ,Blue color for white balance.  
Gain: Adjust the brightness level of Red ,Green,Blue.  
Offset: Adjust the contrast level of Red, Green,Blue.

## Smooth Picture(for DK5153Z series only)

- Use / to adjust. This allows the projector to display a higher resolution source than its native resolution without losing any pixel data.

## Picture Mode Reset

- Press  and use / to scroll through submenus.
- **Current:** Press  to reset current Picture Mode to the default settings.
- **All:** Press  to reset all Picture Mode to the default settings.

### Note:

“Picture Mode Reset” is only reset according to input signal.

## ALIGNMENT Menu

Aspect Ratio	Fill, 4:3, 16:9, Letter Box, 21:9, 16:10, Auto
Digital Zoom	Zoom In: 0~10 (1.0x~2.0x) Zoom Out: -40~0 (0.8x~1.0x) Image Shift: H Image Shift, V Image Shift
Keystone	V Keystone: -30~0~30 H Keystone: -30~0~30
4 Corner	Corner: Top-Left, Top-Right, Bottom-Left, Bottom-Right H: 0~200, V: 0~200 H: 0~1280, V: 0~720 (for DK5153Z series only)
Masking	Top: 0~100 Bottom: 0~100 Left: 0~100 Right: 0~100
Projection	Front, Rear, Front+ Ceiling, Rear+ Ceiling
Screen Settings	Screen Format: 16:10, 16:9, 4:3, 21:9 Screen Position: Grey Out, -60~0~60(When 16:9), -160~0~160(When 4:3), -191~0~191(When 21:9)
Warping	Pincushion/Barrel, Arc, Rotation <b>(for DK5153Z series only)</b>
Edge Blend	Edge Blending, Projector Position, Horizontal, Vertical, Reset <b>(for DK5153Z series only)</b>
Alignment Reset	(OK, Cancel)

DU5053Z / DU5051Z

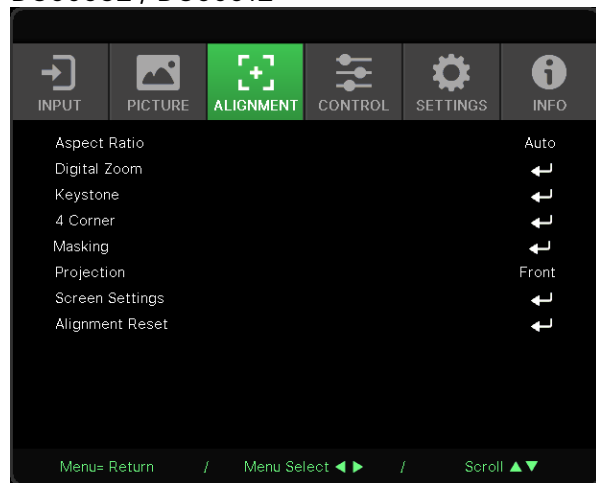

DK5153Z

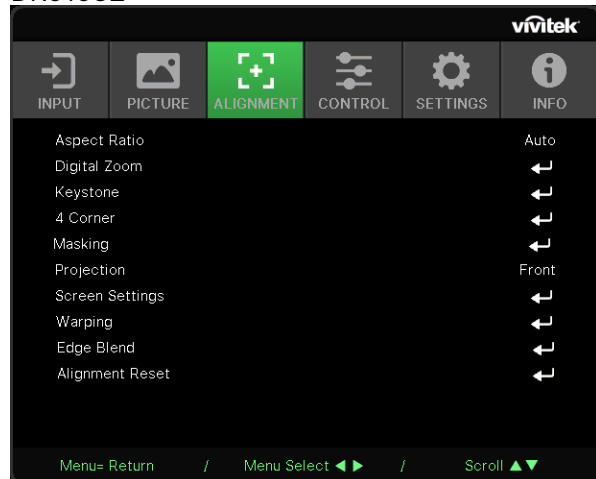

## Aspect Ratio

- Use ◀/▶ to select the image aspect ration (Fill ,4:3 ,16:9 or 16:10 , Letter Box ,21:9, Auto)

## Digital Zoom

- Press ↵ and use ▼/▲ to scroll through submenus.
- **Zoom In:** Use ◀/▶ to make the image seem to large the content from 0~10 value.
- **Zoom Out:** Use ◀/▶ to make the image seem to small the image from -40~0 value. Adjust Zoom Out will reset HV image shift to default value.
- **Image Shift:** Press ↵ and use ▼/▲ to scroll through submenus.  
H Image Shift: Use ◀/▶ to Shift the image Horizontally (left / right).  
V Image Shift: Use ◀/▶ to Shift the image Vertically (up / down).  
Depend on Zoom Out, not fixed.

## Keystone

- Press ↵ and use ▼/▲ to scroll through submenus.
- **V Keystone:** Use ◀/▶ to adjust the value to correct the image Vertical distortion. The adjustable value is  $\pm 30$ .
- **H Keystone:** Use ◀/▶ to adjust the Horizontal distortion of image. The adjustable value is  $\pm 30$ .

## 4 Corner

This function is used to correct the image distortion that may occur in a corner due to installation or projected surface.

- Press ↵ and use ▼/▲ to scroll through submenus.
- **Corner:** Use ◀/▶ to select a corner (Top Left, Top Right, Bottom Left, Bottom Right).
- **H:** Use ◀/▶ to increase or decrease the Horizontal value.
- **V:** Use ◀/▶ to increase or decrease the Vertical value.

## Masking

- Press ↵ and use ▼/▲ to scroll through submenus.
- Use ◀/▶ to adjust Masking function on the screen from Top side, Bottom side, Left side and Right side value.

## Projection









- Use ◀/▶ to select the Projection position.
- **Front:** Install the projector on the desktop and project the image forward.
- **Rear:** Install the projector on the desktop and project the image from the rear of the screen.
- **Front Ceiling:** Mount the projector on the ceiling and project the image forward.
- **Rear Ceiling:** Mount the projector on the ceiling and project the image from the rear of the screen.

## Screen Setting













- Press ↵ and use ▼/▲ to scroll through submenus.
- **Screen Format:** Use ◀/▶ to select the screen format to 16:10, 16:9, 4:3 and 21:9.
- **Screen Position:** Use ◀/▶ to adjust the Position of Screen.

## Warping (for DK5153Z series only)

This function is used to adjust the image distortion due to installation or projected surface.

- Press  and use / to scroll through submenus.
- **Pincushion/Barrel:** Use / to correct pincushion/barrel distortion.
- **Arc:** Use / to correct distortion of individual side including top, bottom, left or right side.
- **Rotation:** Use / to correct incorrect angle of image.

## Edge Blend (for DK5153Z series only)

- Press  and use / to scroll through submenus.
- **Edge Blending:** Use / to Enable / Disable edge blending function.
- **Projector Position:** Use / to select projector installation position.
- **Horizontal:** Use / to adjust the Horizontal width of image blending. The adjustable value is 1200.
- **Vertical:** Use / to adjust the Vertical width of image blending. The adjustable value is 800.
- **Reset:** Press  to reset edge blending to default settings.

## Alignment Reset

- Press  to reset all Alignment to the default settings.

# CONTROL Menu

Direct Power On	Off, On
Light Source	<b>DU5053Z / DU5051Z</b> Light Mode: Normal, ECO, Custom Light <b>DK5153Z</b> Light Mode: Normal, Silent, Custom Light Custom Light: 25~100 Constant Brightness: Off, On Viviblack: Dynamic Black, Light Off Timer
High Altitude	Normal, High
IR Control	Front+ Rear IR On, Front IR On, Rear IR On, Front+ Rear IR Off
Remote ID	Default~7
HDBaseT	HDBaseT-IR_RS232_RJ45: Off, On HDBaseT EDID: Enhanced, Standard
Network	Network State: Connect, Disconnect DHCP: Off, On IP Address: 0~255, 0~255, 0~255, 0~255 Subnet Mask: 0~255, 0~255, 0~255, 0~255 Gateway: 0~255, 0~255, 0~255, 0~255 DNS: 0~255, 0~255, 0~255, 0~255 Apply: OK, Cancel
Rental Mode	Power Locked Level : 60~100 Power Locked Level Reset Usage Locked Time : Disable, Enable Usage Locked Settings (HRS) : 1~9999 Expiration Time Reset Change Password: New Password, Confirm Password

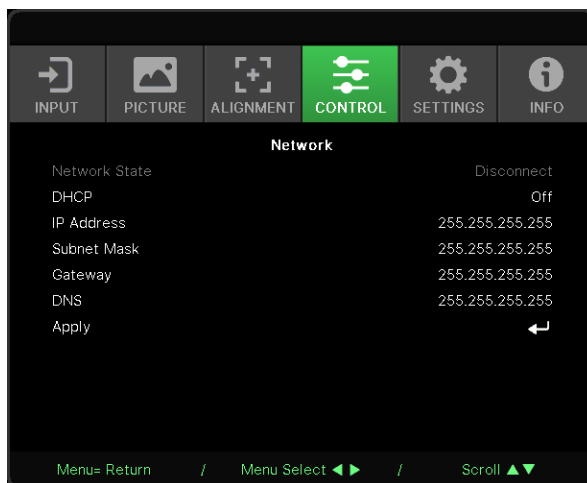
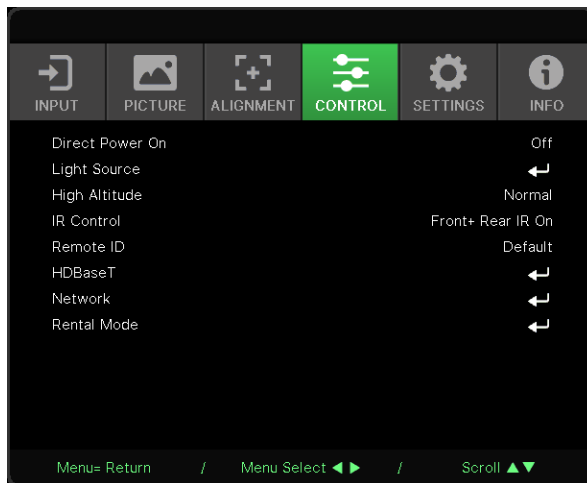

## Direct Power On

- Use ◀/▶ to switch On/Off.  
This function is set to Off by default. When it is set to On, the projector will turn on automatically when the AC power is turned on the next time. You can use this function and the power switch (instead of the remote control) to turn on the projector.

## Light Source

- Press ↵ and use ▼/▲ to scroll through submenus.
- **Light Mode:** Use ◀/▶ to select Normal, Eco (Silent), Custom Light.  
**Note:** Silent mode is only for DK5153Z.
- **Custom Light:** Use ◀/▶ to adjust brightness level between 25% to 100%.
- **Constant Brightness:** Use ◀/▶ to switch On/Off.
- **ViviBlack:** Press ↵ and use ▼/▲ to scroll through submenus.  
Dynamic Black: Use ◀/▶ to switch On/Off.  
Light Off Timer: Use ◀/▶ to select light-off time(Disable, 1 Sec./ 2 Sec., 3 Sec., 4 Sec. ).

## High Altitude

- Use ◀/▶ to adjust cooling fan speed (Normal, High).

## IR Control

- Use ◀/▶ to select the preferred IR control location (Front+ Rear IR On, Front IR On, Rear IR On, Front+ Rear IR Off).  
This function let you select which IR remote controller receiver is active.

## Remote ID

Display current projector ID and remote control ID number. To set a unique ID for the projector and control independently.

## HDBaseT













- Press ↵ and use ▼/▲ to scroll through submenus.
- **HDBaseT-IR\_RS232\_RJ45:** Use ◀/▶ to switch HDBaseT-IR\_RS232\_RJ45 On/Off Enable the control function of HDBaseT with IR, RS232 and RJ45.
- **HDBaseT EDID:** Use ◀/▶ to select HDBaseT mode (Enhanced, Standard).

### Note:

If HDBaseT control set to On, Low power mode will set to "On by HDBaseT", and disable this function to select.

## Network

Use this function to configure the network settings, so that you can control the projector via the network.

- Press  and use / to scroll through submenus.
- **Network State:** Connect / Disconnect the network automatically.
- **DHCP:** Use / to Set DHCP to On/Off.  
When DHCP is set to On, the DHCP server of the domain will assign an IP address to the projector. The IP address will appear on the IP address window without applying any input. If the domain cannot assign any IP address, 0.0.0.0 will be shown on the IP address window.
- **IP Address:** Press  to show the IP address input window.  
Use / to select the number in the address to change.  
Use / to increase or decrease the number in the IP address.  
(Example :Network IP Address 172. xxx. xxx. xxx.)
- **Subnet Mask:** Set the subnet mask. The input method is the same as the setting for IP address.
- **Gateway:** Set the gateway. The input method is the same as the setting for IP address.
- **DNS:** Set the DNS. The input method is the same as the setting for IP address.
- **Apply:** Press  and use / to scroll through submenus.

**Note:**

After power-on, please wait 2 minutes for the network initialization to complete before the Network options can be accessed.

### Wired LAN Terminal functionalities

Remote control and monitoring of a projector from a PC (or Laptop) via wired LAN is also possible. Compatibility with Crestron / AMX (Device Discovery) / Extron control boxes enables not only collective projector management on a network but also management from a control panel on a PC (or Laptop) browser screen.

- Crestron is a registered trademark of Crestron Electronics, Inc. of the United States.
- Extron is a registered trademark of Extron Electronics, Inc. of the United States.
- AMX is a registered trademark of AMX LLC of the United States.
- PJLink applied for trademark and logo registration in Japan, the United States of America, and other countries by JBMIA.

#### Note:

*To use network control function, the password on web page for administrator account must be set up first.*

### Supported External Devices

This projector is supported by the specified commands of the Crestron Electronics controller and related software.

<http://www.crestron.com/>

This projector is supported by AMX ( Device Discovery ).

<http://www.amx.com/>

This projector is compliant to support Extron device(s) for reference.

<http://www.extron.com/>

This projector supports all commands of PJLink Class1 (Version 1.00).

<http://pjlink.jbmia.or.jp/english/>

For more detail of information about the diverse types of external devices which can be connected to the LAN/RJ45 port and remote/control the projector, as well as the related control commands supporting for each external device, kindly please get contact with the Support-Service team directly.

### Connecting with LAN

1. Connect an RJ45 cable to RJ45 ports on the projector and the PC (Laptop).

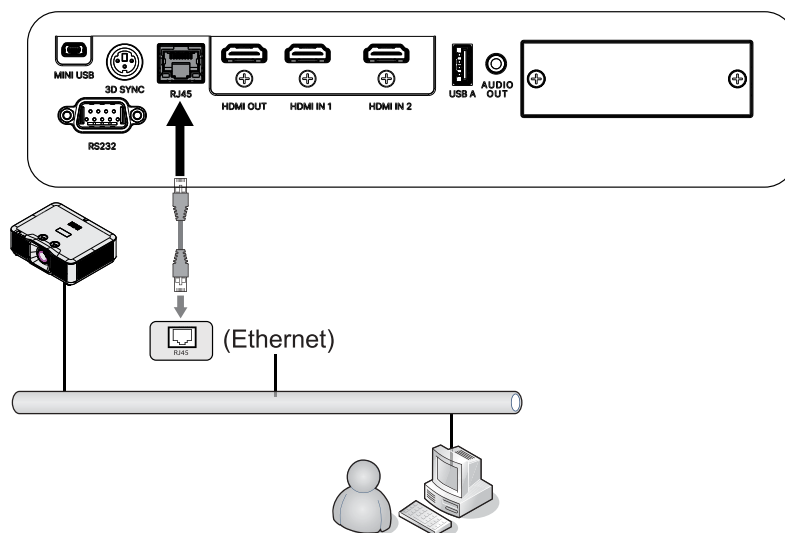

2. On the PC (Laptop), select Start → Control Panel →Network and Internet.

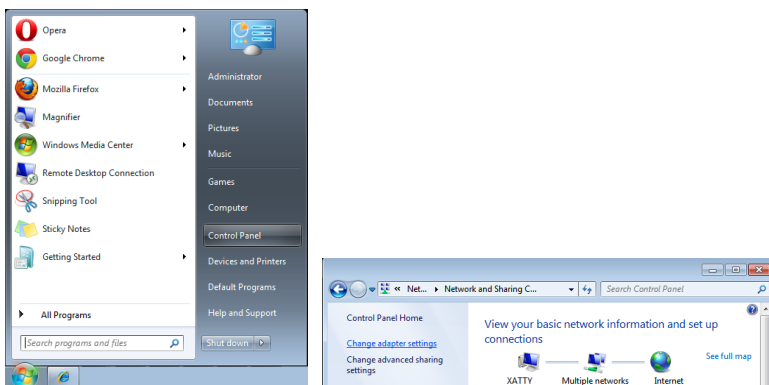

3. Right-click on Local Area Connection, and select Properties.
4. In the Properties window, select the Networking tab, and select Internet Protocol (TCP/IP).
5. Click Properties.
6. Click Use the following IP address and fill in the IP address and Subnet mask, then click OK.

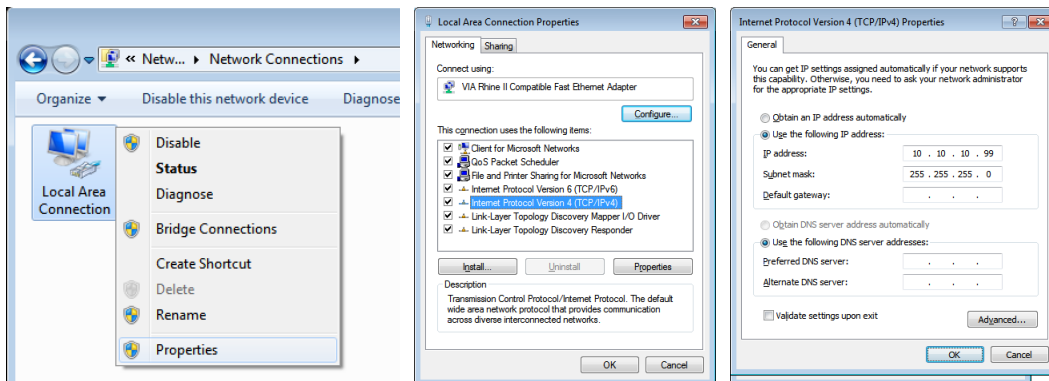

7. Press the Menu button on the projector.
8. Select CONTROL → Network
9. After getting into Network, input the following:
  - DHCP: Off
  - IP Address: 10.10.10.10
  - Subnet Mask: 255.255.255.0
  - Gateway: 0.0.0.0
  - DNS Server: 0.0.0.0

10. Press (Enter) / ► to confirm settings.

Open a web browser

(for example, Microsoft Internet Explorer with Adobe Flash Player 9.0 or higher).

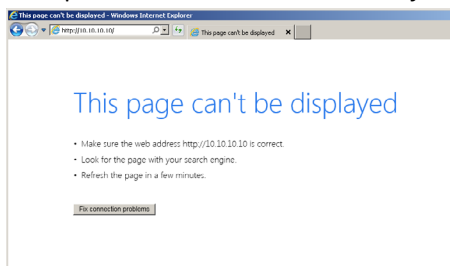

11. In the Address bar, input the IP address: 10.10.10.10.
12. Press (Enter) / ►.

The projector is setup for remote management. The LAN/RJ45 function displays as follows. The first time password setup:

The screenshot shows the 'Admin' interface of the Projector Web Server. The main content area is titled 'Change Username and Password for Webpage'. It contains two sections: 'Change Username and Password for Webpage' and 'Change PJLink Password'. Each section has input fields for 'Enter User Name', 'Enter New password', and 'Confirm New password'. The 'Enter User Name' field is pre-filled with 'admin'. To the right of the input fields, there are bulleted instructions: 'Reusing passwords is not recommended', 'Password cannot be blank', 'Password needs to be at least eight single-byte characters in length and use a mix of the following 3 types of letters' (Upper-case letters, Lower-case letters, Digits), and 'The user name and password are used by the Web Control function. Changing the current settings may interrupt the connection. For details, refer to the user's manual.' An 'Apply' button is located at the bottom right of the form.

The screenshot shows the 'Admin - System Status' page. On the left is a navigation menu with options: System Status, General Setup, Projector Control, Network Setup, Alert Setup, Crestron, Reset to Default, and Reboot System. The main content area displays system information in a table format:

<b>Model Name</b>	DU5053Z
<b>Projector Name</b>	
<b>FW Version</b>	
System	A04
LAN	A04
<b>LAN Status</b>	
IP Address	10.10.10.10
Subnet Mask	255.255.255.0
Default Gateway	0.0.0.0
MAC Address	00:02:18:0E:00:01

At the bottom of the page, there is a language dropdown menu set to 'English' and an 'Apply' button.

## Preparing Email Alerts

1. Make sure that user can access the homepage of LAN RJ45 function by web browser (for ex-ample, Microsoft Internet Explorer v6.01/v8.0).
2. From the Homepage of LAN/RJ45, click Alert Mail Settings.
3. By default, these input boxes in Alert Mail Settings are blank.

The screenshot shows the 'Admin > Alert Setup' page of the Vivitek Projector Web Server. The page is divided into several sections:

- System Status**: A section for monitoring the projector's status.
- General Setup**: Contains 'Alert Type' with checkboxes for 'Fan Error', 'High Temp Warning', and 'Light Source Error'. The 'Alert Mail Notification' checkbox is checked.
- SMTP Setting**: Includes input fields for 'SMTP Server', 'From', 'Username', and 'Password'.
- Email Setting**: Includes input fields for 'Mail Subject', 'Mail Content', and 'To'. There are 'Apply' and 'Send Test Mail' buttons at the bottom right of this section.

4. For Sending alert mail, input the following:
  - The SMTP field is the mail server for sending out email (SMTP protocol). This is a required field.
  - The To field is the recipient's email address (for example, the projector administrator). This is a required field.
  - The From field is the sender's email address (for example, the projector administrator). This is a required field.
  - Select the alert conditions by checking the desired boxes.

Note: Fill in all fields as specified. User can click Send Test Mail to test what setting is correct. For successful sending an e-mail alert, you must select alert conditions and enter a correct e-mail address.

## Web UI for Crestron Setting

- **Crestron System**

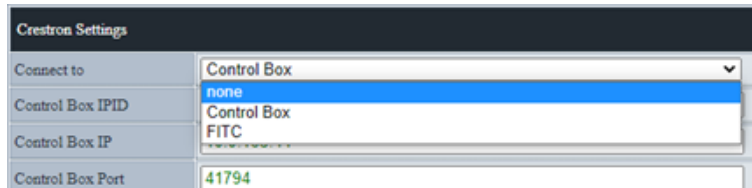

Select “Connect to” to select what Crestron interface will set. If select “none”, its mean disable Crestron function.



1. The red block is for Crestron device (Control box or VC4) setting. If projector would connect to VC4, the “VC4 RoomID” need setting.
2. The Roomview is running in Server mode in projector. You can define the IPID in “Roomview IPID” field.
3. If enable the “Use SSL”, the “Device Username” & “Device Password” could be edited. This information is for Crestron device.
4. Setting the “Use SSL”, “Use Certificate” to change projector with Crestron communication mode by secure or non-secure mode.
5. The blue block is for FITC (Fusion in the Cloud or Fusion on Prem) setting. If select “FITC” in “Connect to”, these fields will be edited.
6. The “Auto Discovery” is for Crestron tool search projector.

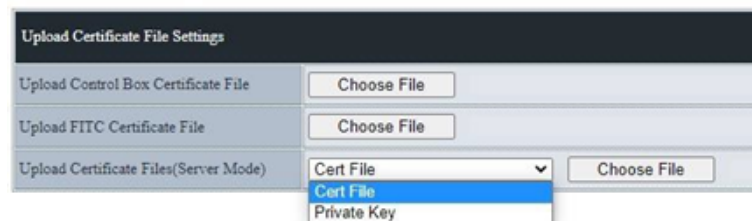

7. If first time enable the “Use Certificate”, the Certificate file need to be upload.
8. The Upload Certificate File Settings page includes Crestron device (Control box, VC4), Fusion in the Cloud or Fusion on Prem as server mode (FITC) & Roomview or Fusion on Prem as client mode (Server mode) 3 parts.

● **XiO System**



1. The XiO system would be running. The projector must get current time from NTP server. If the "Serial Number" field is empty, its mean didn't get current time when projector bootup.
2. When user would claim the projector in the XiO Cloud, just copy the "MAC Address" & "Serial Number" information to XiO Cloud.
3. After claim success, projector will be control on next time power ON.

● **XiO Certificate Settings**

This is a hidden page. To key in the webpage name: "/XioSetting.asp" behind the Projector's IP in URL field.

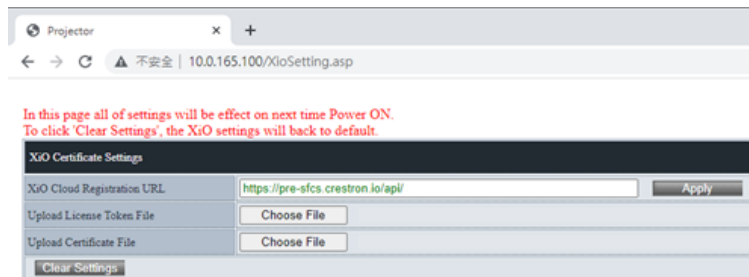

1. XiO Cloud Registration URL: Input the test or certificate full URL in this filed.
2. Upload License Token File: Upload a new License Token file.
3. Upload Certificate File: Upload a new certificate file.
4. Clear Settings: To clear all of settings in this page. The XiO setting will back to default.

### RS232 by Telnet Function

Besides projector connected to RS232 interface with “Hyper-Terminal” communication by dedicated RS232 command control, there is alternative RS232 command control way, so called “RS232 by TELNET” for LAN/RJ45 interface.

#### Quick Start-Guide for “RS232 by TELNET”

Check and get the IP-Address on OSD of the projector.

Make sure that laptop/PC can access the web-page of the projector.

Make sure that “Windows Firewall” setting to be disabled in case of “TELNET” function filtering out by laptop/PC.

Start ⇒ All Programs ⇒ Accessories ⇒ Command Prompt

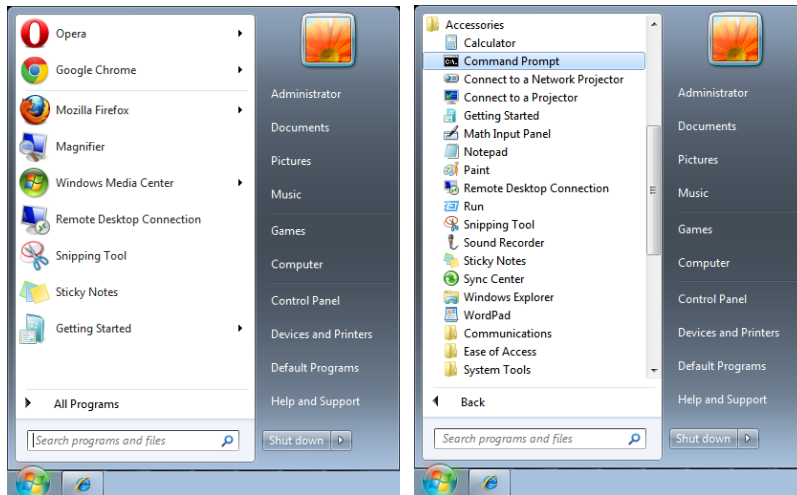

Input the command format like the below:

telnet ttt.xxx.yyy.zzz 7000 (“Enter” key pressed)

(ttt.xxx.yyy.zzz: IP-Address of the projector)

If Telnet-Connection ready, and user can have RS232 command input, then “Enter” key pressed, the RS232 command will be workable.

### How to have TELNET enabled in Windows

By default installation for Windows, “TELNET” function is not included. But end-user can have it by way of “Turn Windows features On or Off” to be enabled.

Open “Control Panel” in Windows

Open “Programs”

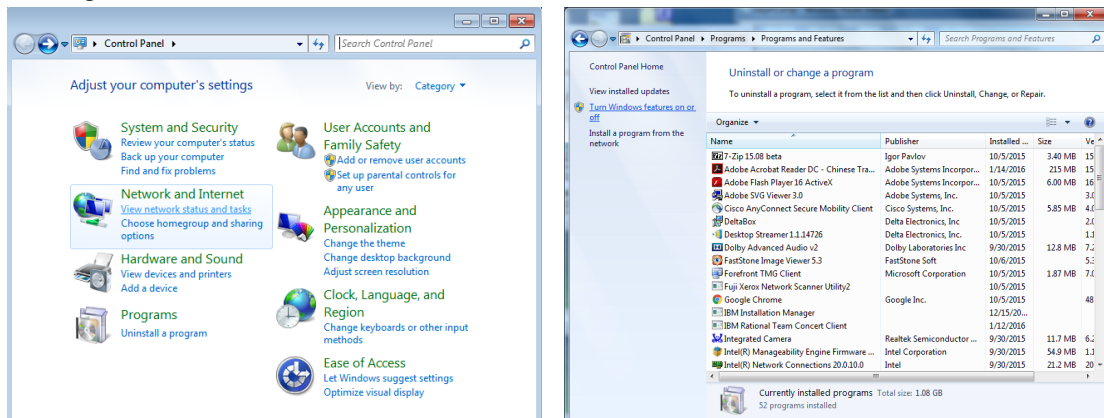

Select “Turn Windows features on or off” to open  
 Have “Telnet Client” option checked, then press “OK” button.

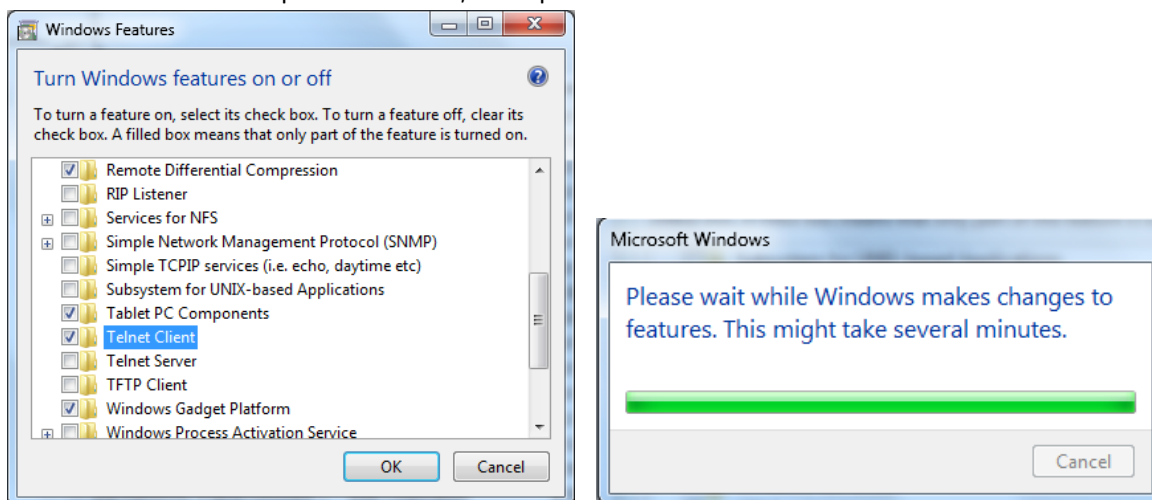

**Specsheet for “RS232 by TELNET” :**

1. Telnet: TCP
2. Telnet port: 7000  
(for more detail, kindly please get contact with the service agent or team)
3. Telnet utility: Windows “TELNET.exe” (console mode)
4. Disconnection for RS232-by-Telnet control normally: Close Windows Telnet utility directly after TELNET connection ready
5. Limitation 1 for Telnet-Control: there is less than 50 bytes for successive network payload for Telnet-Control application.  
 Limitation 2 for Telnet-Control: there is less than 26 bytes for one complete RS232 command for Telnet-Control.  
 Limitation 3 for Telnet-Control: Minimum delay for next RS232 command must be more than 200 (ms).  
 (\*, In Windows built-in “TELNET.exe” utility, “Enter” key pressed will have “Carriage-Return” and “New-Line” code.)

**Rental Mode**

- Press **↵** and use **▼/▲** to scroll through submenus and enter 5 digits password.
- **Power Locked Level:** Press **↵** and use **▼/▲** to scroll through submenus.  
 Power Locked Level: To select fixed power level output ( 60~100).  
 Power Locked Level Reset: To reset power level output to default.
- **Usage Locked Time:** Press **↵** and use **▼/▲** to scroll through submenus.  
 Usage Locked Time: To select Disable / Enable usage locked time.  
 Usage Time Setting (HRS): Set the usage time. There will jump out a caution window when time run out.  
 Expiration Time Reset: To restart and countdown the expiration time.
- **Change Password:** Press **↵** to change the password of Rental Mode.

**Note:**







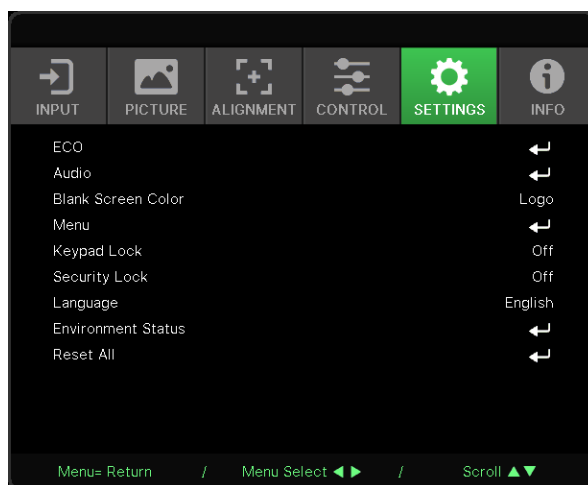

If want to enable Rental Mode, please contact local agent to obtain 5 digits password.

## SETTINGS Menu









Eco	Standby Power: Normal, ECO, On By Lan, (On By HDBaseT)
	No Signal Power Off (min.): 0~30~180
	Sleep Timer (min.): 0~600
Audio	Volume: 0~5~10
	Internal Speaker: Off, On
	Mute: Off, On
Blank Screen Color	Logo, Black, Red, Green, Blue, White
Menu	Logo: Std., Black, Blue
	Message: Off, On
	Menu Position: Center, Up, Down, Left, Right
	Menu Timer: Off, 20 sec., 40 sec., 60 sec.
	Menu Translucent: Off, 50%, 100%
Keypad Lock	Off, On
Security Lock	Off, On
Language	English, Français, Deutsch, Español, Português, 简体中文, 繁體中文, Italiano, Norsk, Svenska, Nederlands, Русский, Polski, Suomi, Ελληνικά, 한국어, Magyar, Čeština, Türkçe, 日本語, Dansk, Ínø
Environment Status	execute
Reset All	OK, Cancel





## Eco

- Press  and use / to scroll through submenus.
- **Standby Power:** Use / to switch Normal / Eco / On by LAN / On By HDBaseT (Only shown and gray out when HDBaseT-IR\_RS232\_RJ45 set "On").
- **No Signal Power Off (mins):** Use / to increase or decrease time lapse before automatic Power Off mode to count down under no signal before turning off projector automatically.
- **Sleep Timer (mins):** Use / to increase or decrease time lapse before automatic sleep mode.













## Audio

- Press  and use / to scroll through submenus.
- **Volume:** Use / to increase or decrease the projector sound volume.
- **Internal Speaker:** Use / to switch On/Off the built in Internal Speaker of projector.
- **Mute:** Use / to switch On/Off the built in Speaker of projector.

## Blank Screen Color

- Use / to select screen background color (Logo, Black, Red, Green, Blue, White).

## Menu

- Press  and use / to scroll through submenus.
- **Logo:** Use / to select the Logo (Std., Black, Blue).
- **Message:** Use / to switch On/Off.
- **Menu Position:** Use / to select the menu position (Center,Up,Down,Left,Right).
- **Menu Timer:** Use / to switch time : Off / 20sec. / 40sec. / 60sec. to pop off Menu.
- **Menu Translucent:** Use / to switch Off / 50% /100% for Menu transparency.

## Keypad Lock

- Use / to to switch On/Off for Keypad lock.

### Note :

To unlock by keypad, please press "▼" for 5 sec and then pop-out "keypad unlock".

## Security Lock

- Use ◀/▶ to switch On/Off for Security Lock.

## Password

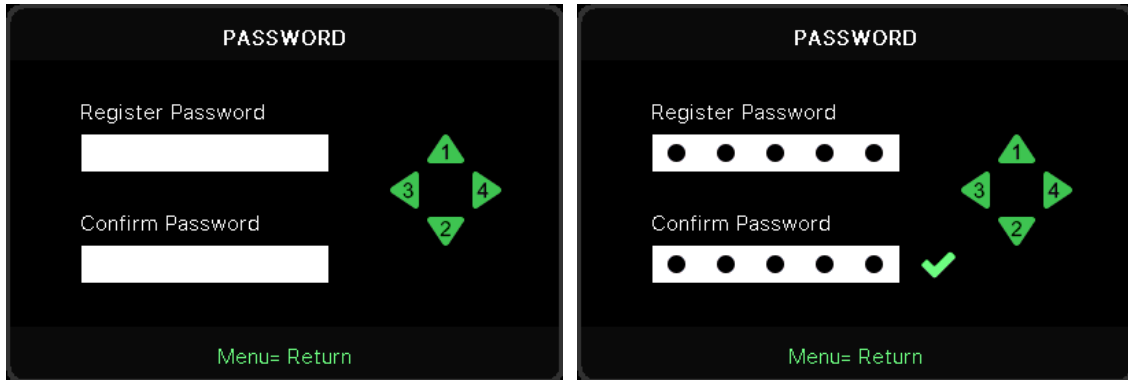

- When Security Lock is on, show popup “password input”.
- Press ▲/▼/◀/▶ to set the password, total 5 digits.

**Note:**

Every time will show “password check” to key in when startup. If wrong over 5 times ,please contact with local service center.

## Language

- Press and use ▼/▲ to scroll through submenus.
- Press ↵ to enter the languages submenus.
- Press ▲/▼/◀/▶ button to scroll and highlight your language.
- Press the MENU button to exit the language submenus.

## Environment Status

- Press ↵ to display the Environment Status sub menu.

Environment Status					
T1	25	Fan1	1100	Fan11	1100
T2	25	Fan2	1100	Fan12	1100
T3	25	Fan3	1100	Fan13	1100
T4	25	Fan4	1100	Fan14	1100
T5	25	Fan5	1100	Fan15	1100
T6	25	Fan6	1100		
T7	25	Fan7	1100		
T8	25	Fan8	1100		
T9	25	Fan9	1100		
T10	25	Fan10	1100		
T State	1st				
Menu= Exit					

## Reset All

- Press  to select the reset all will show popup "reset all confirm" to check.

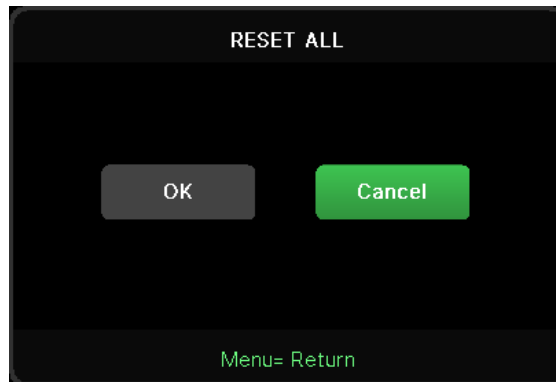

**Note:**

Depending on the video source, not all items in the OSD are available. Items that are not available cannot be accessed and are grayed out.

## INFO Screen

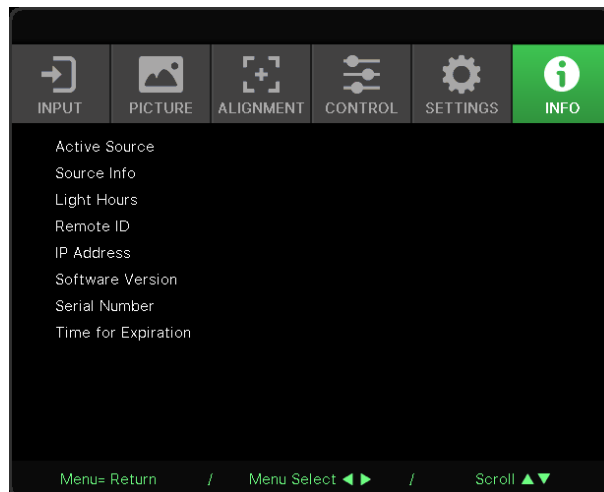

This screen displays the projector current status information to be used for technical support.

## 4.Troubleshooting

### Common Problems and Solutions

These guidelines provide tips to deal with problems you may encounter while using the projector. If the problem remains unsolved, contact your dealer for assistance.

Often after time spent troubleshooting, the problem is traced to something as simple as a loose connection.

Check the following before proceeding to the problem-specific solutions.

- Use some other electrical device to confirm that the electrical outlet is working.
- Ensure the projector is turned on.
- Ensure all connections are securely attached.
- Ensure the attached device is turned on.
- Ensure a connected PC is not in suspending mode.
- Ensure a connected notebook computer is configured for an external display.

(This is usually done by pressing an Fn-key combination on the notebook.)

### Troubleshooting Tips

In each problem-specific section, try the steps in the order suggested. This may help you to solve the problem more quickly.

Try to pin point the problem and thus avoid replacing non-defective parts.

For example, if you replace batteries and the problem remains, put the original batteries back and go to the next step.

Keep a record of the steps you take when troubleshooting: The information may be useful when calling for technical support or for passing on to service personnel.

## LED Indicator Messages

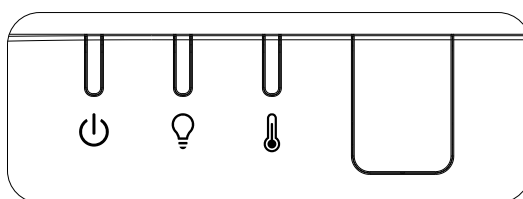

LED Code Messages	Power LED (Green)	Light LED (ORANGE)	Temp LED (Red)
Light Ready	ON	OFF	OFF
Start	Flashing	OFF	OFF
Cooling	Flashing	OFF	OFF
1W MCU detects scaler stops working	2 blinks	OFF	OFF
Over Temperature T1 / Sensor T1 lost connect	OFF	1 blinks	ON
Over Temperature T2 / Sensor T2 lost connect	OFF	2 blinks	ON
Over Temperature T3 / Sensor T3 lost connect	OFF	3 blinks	ON
Over Temperature T4 / Sensor T4 lost connect	OFF	4 blinks	ON
Over Temperature T5 / Sensor T5 lost connect	OFF	5 blinks	ON
Over Temperature T6 / Sensor T6 lost connect	OFF	6 blinks	ON
Thermal Break Sensor error	4 blinks	OFF	OFF
Laser Light Source error	4 blinks	1 blinks	OFF
Laser 54V error	4 blinks	4 blinks	OFF
FAN1 error	6 blinks	1 blinks	OFF
FAN2 error	6 blinks	2 blinks	OFF
FAN3 error	6 blinks	3 blinks	OFF
FAN4 error	6 blinks	4 blinks	OFF
FAN5 error	6 blinks	5 blinks	OFF
FAN6 error	6 blinks	6 blinks	OFF
FAN7 error	6 blinks	7 blinks	OFF
FAN8 error	6 blinks	8 blinks	OFF
Color wheel error	9 blinks	OFF	OFF
Phosphor wheel error	9 blinks	1 blinks	OFF

**Note:**

In the event of an error, please disconnect the AC power cord and wait for one (1) minute before restarting the projector. If the Power or Light source LEDs are still blinking or the Over Temp LED is lit, contact your service center.

## Image Problems Q&A

### Q. NO image appears on the screen

- Verify the settings on your notebook or desktop PC.
- Turn off all equipment and power up again in the correct order.

### Q. The image is blurred

- Adjust the Focus on the projector.
- Ensure the projector-to-screen distance is within the specified range.
- Check that the projector lens is clean.

### Q. The image is reversed

- Check the Projection setting on the ALIGNMENT menu of the OSD.

### Q. The image is streaked

- To ensure the problem is not caused by a connected PC's video card, connect to another computer.

### Q. The image is flat with no contrast

- Adjust the Contrast setting on the PICTURE menu of the OSD.

### Q. The colour of the projected image does not match the source image.

- Adjust the Color Temperature and Gamma settings on the PICTURE > Advanced menu of the OSD.

## Light Source Problems

### Q. There is no light from the projector

- Check that the power cable is securely connected.
- Ensure the power source is good by testing with another electrical device.
- Restart the projector in the correct order and check that the Power LED is on.

## Remote Control Problems

### Q. The projector does not respond to the remote control

- Direct the remote control towards remote sensor on the projector.
- Ensure the path between remote and sensor is not obstructed.
- Turn off any fluorescent lights in the room.
- Check the battery polarity.
- Replace the batteries.
- Turn off other Infrared-enabled devices in the vicinity.
- Have the remote control serviced.

## Audio Problems

### Q. There is no sound

- Adjust the volume on the remote control.
- Adjust the volume of the audio source.
- Check the audio cable connection.
- Test the source audio output with other speakers.
- Have the projector serviced.

### Q. The sound is distorted

- Check the audio cable connection.
- Test the source audio output with other speakers.
- Have the projector serviced.

## Having the Projector Serviced

If you are unable to solve the problem, you should have the projector serviced. Pack the projector in the original carton. Include a description of the problem and a checklist of the steps you took when trying to fix the problem: The information may be useful to service personnel. For servicing, return the projector to the place you purchased it.

## HDMI Q&A

### Q. What is the difference between a “Standard” HDMI cable and a “High-Speed” HDMI cable?

Recently, HDMI Licensing, LLC announced that cables would be tested as Standard or High-Speed cables.

Standard (or “category 1”) HDMI cables have been tested to perform at speeds of 75Mhz or up to 2.25Gbps, which is the equivalent of a 720p/1080i signal.

High Speed (or “category 2”) HDMI cables have been tested to perform at speeds of 340Mhz or up to 10.2Gbps, which is the highest bandwidth currently available over an HDMI cable and can successfully handle 1080p signals including those at increased color depths and/or increased refresh rates from the Source. High-Speed cables are also able to accommodate higher resolution displays, such as WQXGA cinema monitors (resolution of 2560 x 1600).

### Q. How do I run HDMI cables longer than 10 meters?

There are many HDMI Adapters working on HDMI solutions that extend a cable’s effective distance from the typical 10 meter range to much longer lengths. These companies manufacture a variety of solutions that include active cables (active electronics built into cables that boost and extend the cable’s signal), repeaters, amplifiers as well as CAT5/6 and fiber solutions.

### Q. How can I tell if a cable is an HDMI certified cable?

All HDMI products are required to be certified by the manufacturer as part of the HDMI Compliance Test Specification. However, there may be instances where cables bearing the HDMI logo are available but have not been properly tested. HDMI Licensing, LLC actively investigates these instances to ensure that the HDMI trademark is properly used in the market. We recommend that consumers buy their cables from a reputable source and a company that is trusted.

# 5. Specifications

## Projector Dimensions

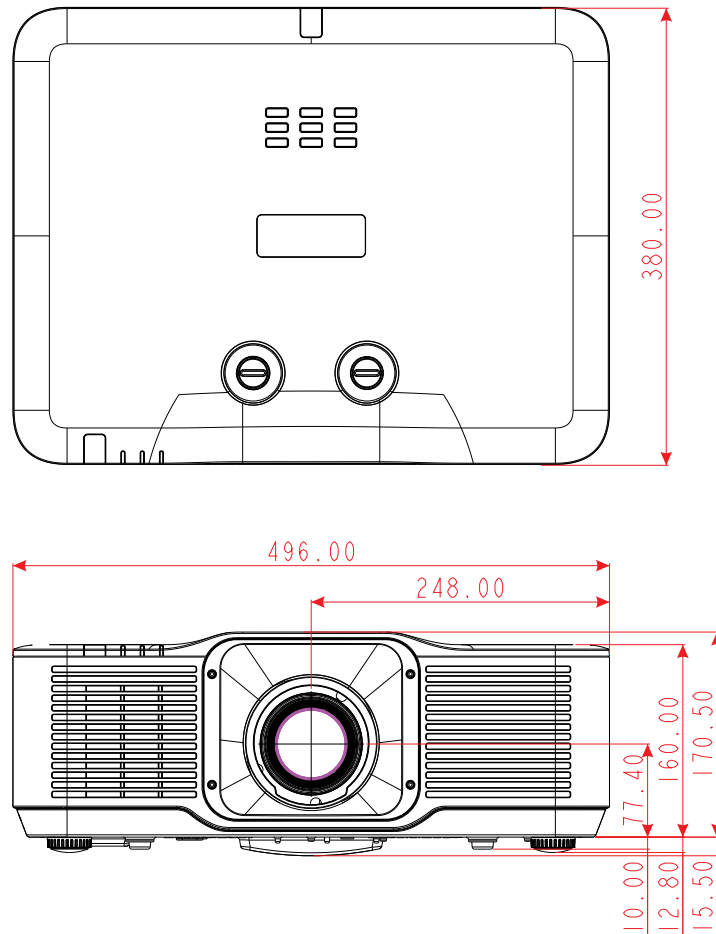

## Projector DataSheet

Model Name	DU5053Z	DU5051Z
Display Type	Single Chip 0.67" DLP Technology by TI	
Brightness**	7,700 Lumen	6,300 Lumen
Native Resolution	WUXGA (1920 x 1200)	
Maximum Resolution	UHD (3840×2160) @60Hz	
Contrast Ratio	2,000:1 / 3,000,000:1 (Full On/Off)	
Laser Life/Type	Up to 20,000 hours (Laser Phosphor Light Engine)	
Throw Ratio*	1.15 - 1.9 :1 (STD)	
Image Size (Diagonal)*	60" - 250" (best @ 80") (STD)	
Projection Distance*	best @ 1.989m (1.482m - 6.292m) (STD)	
Projection Lens*	F#2.49 - 3.18, f =17.32 - 27.97mm	
Zoom Ratio*	1.65x	
Aspect Ratio	16:10 (Default)	
Offset	115% (STD)	
Keystone Correction	Horizontal ±30°, Vertical ±30°	
Horizontal Frequency	15, 31 – 102Hz	
Vertical Scan Rate	24 - 30Hz, 47 – 120Hz	
3D Functionality	Yes (DLP® Link™, HDMI v2.0 Blu-ray, side by side, frame packing, top and bottom, frame sequential)	
Lens Shift Range**	V: -95%~+115% (STD) H: Left 2% to Right 2%	
Computer Compatibility	VGA, SVGA, XGA, WXGA, SXGA, SXGA+, UXGA, 1080P, WUXGA, 4K@60hz, Mac	
I/O Connection Ports	HDMI 2.0 (x2) (HDCP v2.3 Compliant), 3D-Sync Out, HDMI Out, Audio-Out (Mini Jack), USB Type A Power (5V/2.0A), RS-232-In, RJ45 (LAN)(10/100Mbps), USB Mini B (Service), HDBaseT™ (100Mbps)(optional), WiFi (IEEE 802.11ac 2.4GHz/5GHz) (optional)	
Projection Method	Table, Ceiling, Portrait with Front or Rear	
Security Solutions	Kensington® Security Slot, Security Bar, Keypad Lock	
Dimensions (WxDxH)	496×380×160mm (19.5" x 14.9" x 6.3") w/o foot	
Weight	13kg (28.6lbs)	
Available Colors	Black	
Speakers	10W x1	
Noise Level	37dB(Normal), 33dB(Eco Mode)	35dB(Normal), 30dB(Eco Mode)
Power Supply	AC 100-240V, 50/60Hz	
Power Consumption	500W@110Vac (Normal), Less than 2W (Network Standby), Less than 0.5W (Eco Standby)	
Environmental Operation Condition	At temperature 0 to 40°C, relative humidity 10% to 85%, non-condensation	
Environmental Storage Condition	At temperature -10 to 60°C, relative humidity 5% to 95%, non-condensation	
Standard Accessories	AC Power Cord, Remote Control w/Batteries, Documentation Kit	

Model Name	DK5153Z
Display Type	Single Chip 0.65" DLP Technology by TI
Brightness**	6,500 Lumen
Native Resolution	1920×1080@60Hz (native) 3840×2160@60Hz (with actuator)
Maximum Resolution	4K UHD (3840 x 2160) @60Hz
Contrast Ratio	2,000:1 (Native) / 3,000,000:1 (Full On/Off)
Laser Life/Type	Up to 20,000 hours (Laser Phosphor Light Engine)
Throw Ratio*	1.15 - 1.9 :1 (STD)
Image Size (Diagonal)*	60" – 250" (best @ 80") (STD)
Projection Distance*	best @ 2.033m (1.515m - 6.429m) (STD)
Projection Lens*	F#2.49 - 3.18, f =17.32 - 27.98mm
Zoom Ratio*	1.65x
Aspect Ratio	16:9 (Default)
Offset	122% (STD)
Keystone Correction	Horizontal ±30°, Vertical ±30°
Horizontal Frequency	15, 31 – 102Hz
Vertical Scan Rate	24 - 30Hz, 47 – 120Hz
3D Functionality	NA
Lens Shift Range**	V: -98%~+122% (STD) H: Left 2% to Right 2%
Computer Compatibility	VGA, SVGA, XGA, WXGA, SXGA, SXGA+, UXGA, 1080P, WUXGA, 4K@60hz, Mac
I/O Connection Ports	HDMI 2.0 (x2) (HDCP v2.3 Compliant), HDMI Out, Audio-Out (Mini Jack), USB Type A Power (5V/2.0A), RS-232-In, RJ45 (LAN)(10/100Mbps), USB Mini B (Service), HDBaseT™ (100Mbps)(optional), WiFi (IEEE 802.11ac 2.4GHz/5GHz) (optional)
Projection Method	Table, Ceiling, Portrait with Front or Rear
Security Solutions	Kensington® Security Slot, Security Bar, Keypad Lock
Dimensions (WxDxH)	496×380×160mm (19.5" x 14.9" x 6.3") w/o foot
Weight	13kg (28.6lbs)
Available Colors	White and Black
Speakers	10W x1
Noise Level	39dB(Normal), 35dB(Eco Mode)
Power Supply	AC 100-240V, 50/60Hz
Power Consumption	500W@110Vac (Normal), Less than 2W (Network Standby), Less than 0.5W (Eco Standby)
Environmental Operation Condition	At temperature 0 to 40°C, relative humidity 10% to 85%, non-condensation
Environmental Storage Condition	At temperature -10 to 60°C, relative humidity 5% to 95%, non-condensation
Standard Accessories	AC Power Cord, Remote Control w/Batteries, Documentation Kit

**Note:**

"\*" : Standard lens.

"\*\*\*": Brightness specifications are in compliance with ISO 21118 standards is equal to ISO lumens

### Projector Timings Table

Signal	Resolution	H-SYNC (KHz)	V-SYNC (Hz)	HDMI (DIGITAL)	HDBaseT
					(DIGITAL)
NTSC	–	15.734	60	–	–
PAL/SECAM	–	15.625	50	–	–
VESA	720 x 400	31.5	70.1	○	○
	640 x 480	31.5	60	O(3D:FS,TB,SBS)	O(3D:FS,TB,SBS)
	640 x 480	35	66.667	MAC13	MAC13
	640 x 480	37.86	72.8	○	○
	640 x 480	37.5	75	○	○
	640 x 480	43.3	85	○	○
	640 x 480	61.9	119.5	○	○
	800 x 600	37.9	60.3	O(3D:FS,TB,SBS)	O(3D:FS,TB,SBS)
	800 x 600	46.9	75	○	○
	800 x 600	48.1	72.2	○	○
	800 x 600	53.7	85.1	○	○
	800 x 600	76.3	120	O(3D:FS)	O(3D:FS)
	832 x 624	49.722	74.546	MAC16	MAC16
	1024 x 768	48.4	60	O(3D:FS,TB,SBS)	O(3D:FS,TB,SBS)
	1024 x 768	56.5	70.1	○	○
	1024 x 768	60.241	75.02	MAC19	MAC19
	1024 x 768	60	75	○	○
	1024 x 768	68.7	85	○	○
	1024 x 768	97.6	120	O(3D:FS)	O(3D:FS)
	1152 x 870	68.68	75.06	MAC21	MAC21
	1280 x 720	45	60	O(3D:FS,TB,SBS)	O(3D:FS,TB,SBS)
	1280 x 720	90	120	○	○
	1280 x 768 (Reduce Blanking)	47.4	60	O(3D:FS,TB,SBS)	O(3D:FS,TB,SBS)
	1280 x 768	47.8	59.9	O(3D:FS,TB,SBS)	O(3D:FS,TB,SBS)
	1280 x 800	49.7	59.8	O(3D:FS,TB,SBS)	O(3D:FS,TB,SBS)
	1280 x 800	62.8	74.9	○	○
	1280 x 800	71.6	84.9	○	○
	1280 x 800	101.6	119.9	O(3D:FS)	O(3D:FS)
	1280 x 1024	64	60	O(3D:TB,SBS)	O(3D:TB,SBS)
	1280 x 1024	80	75	○	○
1280 x 1024	91.1	85	○	○	
1280 x 960	60	60	O(3D:TB,SBS)	O(3D:TB,SBS)	
1280 x 960	85.9	85	○	○	
VESA	1400 x 1050	65.3	60	O(3D:TB,SBS)	O(3D:TB,SBS)
	1440 x 900	55.9	59.9	O(3D:TB,SBS)	O(3D:TB,SBS)
	1600 x 1200	75	60	O(3D:TB)	O(3D:TB)
	1680 x 1050 (Reduce Blanking)	64.67	59.88	O(3D:TB,SBS)	O(3D:TB,SBS)
	1680 x 1050	65.29	59.95	O(3D:TB,SBS)	O(3D:TB,SBS)
	1920 x 1080	67.5	60	O(3D:TB,FS,SBS)	O(3D:TB,FS,SBS)

Signal	Resolution	H-SYNC (KHz)	V-SYNC (Hz)	HDMI (DIGITAL)	HDBaseT
					(DIGITAL)
	1920 x 1200 (Reduce Blanking)	74.038	59.95	O(3D:TB,FS,SBS)	O(3D:TB,FS,SBS)
	1280 x 1024	130	120 (Reduce Blanking)	O	-
	1400 x 1050	93.9	85	O	-
	1440 x 900	114.2	120 (Reduce Blanking)	O	-
	1600 x 1200	87.5	70	O	-
	1600 x 1200	93.8	75	O	-
	1600 x 1200	106.3	85	O	-
	1600 x 1200	152.4	120 (Reduce Blanking)	O	-
	1680 x 1050	82.3	75	O	-
	1680 x 1050	93.9	85	O	-
	1680 x 1050	133.4	120 (Reduce Blanking)	O	-
	1920 x 1200	74.6	60	O(3D:TB,FS,SBS)	-
	1920 x 1200	94	75	O	-
	1920 x 1200	107.2	85	O	-
	3840 x 2160	53,946	23,976	O	O
	3840 x 2160	54	24	O	O
	3840 x 2160	56.25	25	O	O
	3840 x 2160	67.5	30	O	O
	3840 x 2160	112.5	50	O	-
	3840 x 2160	135	60	O	-
EDTV	480p	31.5	60	(3D:FS)	(3D:FS)
HDTV	720p	37.5	50	(3D:FP,TB,SBS)	(3D:FP,TB,SBS)
	720p	45	60	(3D:FP,TB,FS,SBS)	(3D:FP,TB,FS,SBS)
	1080i	28.1	50	(3D:SBS)	(3D:SBS)
	1080p	56.3	50	(3D:TB,SBS)	(3D:TB,SBS)
	1080p	67.5	60	(3D:TB,SBS)	(3D:TB,SBS)

O : Supported frequency  
 - : Not Supported frequency

FS ⇒ Field Sequential

TB ⇒ Top / Bottom

SBS ⇒ Side-By-Side

FP ⇒ Frame Packing

The native resolution of the panel is 1920 x 1200. Resolution other than native resolution may be display with uneven size of text or line.

SDTV \ EDTV \ HDTV may have a little noise is acceptable.

## 6. Regulatory Compliance

### FCC Warning

This equipment has been tested and found to comply with the limits for a Class B digital device pursuant to Part 15 of the FCC Rules. These limits are designed to provide reasonable protection against harmful interference when the equipment is operated in a commercial environment.

This equipment generates, uses, and can radiate radio frequency energy and, if not installed and used in accordance with the instruction manual, may cause harmful interference to radio communications. Operation of this equipment in a residential area is likely to cause harmful interference in which case the user will be required to correct the interference at his/her own expense.

Changes or modifications not expressly approved by the parties responsible for compliance could void the user's authority to operate the equipment.

### Canada

This class B digital apparatus complies with Canadian ICES-003.

### Safety Certifications

FCC, CE, C-Tick, CCC, CECP, KC/KCC, BIS, PSB, BSMI, TGM, CB, cTUVus, ICES-003 (Canada), RoHS

### Disposal and Recycling

This product may contain other electronic waste that can be hazardous if not disposed of properly. Recycle or dispose in accordance with local, state, or federal Laws. For more information, contact the Electronic Industries Alliance at [www.eia.org](http://www.eia.org).

# 7. RS-232 Communication

## Communication parameter setup

You can use the serial control command to input commands for projector control or retrieve its operational data through Windows client terminal software

Item	Parameter:
Bit per Second	9600 bps
Data Bit	8-bit
Parity	None
Stop Bit	1
Flow Control	None

## Operation commands

### Operation command syntax

An operation command is prefixed by character "op", followed by control commands and settings separated by space blank [SP], and ended by carriage return pair "CR" and "ASCII hex 0D". Syntax of serial control commands:

op[SP]<operation command>[SP]<Setting Value>[CR]

op     A constant indicating this is an operation command.

[SP]   Indicate one blank space.

[CR]   Indicate the command ending carriage return pair "CR" and "ASCII hex 0D".

Setting value                 Settings of operation command

Types of setup strings	Characters of settings	Description
Query current setup	?	Question mark "?" indicates querying current setup
Setup	= <settings>	Syntax: Symbol "=" suffixed with setup values
Increase setup order of adjustment items	+	Some settings are changed in steps. Symbol "+" indicates changing one step up
Decrease setup order of adjustment items	-	Some settings are changed in steps. Symbol "-" indicates changing one step down
Execute operation command	None	Certain operation commands execute after input without further setting or regulators.

Examples:		
Control items	Input command row	Projector return message
Query current brightness	op bright ?[CR]	OP BRIGHT = 50
Set up brightness	op bright = 100[CR]	OP BRIGHT = 100
Out of range or not support	op bright = 200[CR]	OP BRIGHT = NA
Illegal command	op abright = 100[CR]	*Illegal format#

Function	Operation	Set	Get	Inc	Dec	EXE	Values
Auto Source	auto.src	V	V				0 = Off 1 = On
HDMI Format	hdmi.format	V	V				0 : Auto 1 : RGB Limited 2 : RGB Full 3 : YUV Limited 4 : YUV Full
HDBaseT Control	hdbaset	V	V				0 : Off 1 : On
HDBaseT Connect	hdbaset.connect		V				0 : Disconnect 1 : Connected
3D	threed	V	V				0 : DLP-Link 1 : IR
3D Sync Invert	threed.syncinvert	V	V				0 = Off 1 = On
3D Format	threed.format	V	V				0 : Auto 1 : Top / Bottom 2 : Frame Sequential 3 : Frame Packing 4 : Side by side 5 : Off
3D Sync Out Delay	threed.syncdelay	V	V				0 ~ 359
<b>Note: 3D commands are only supported by DU5053Z/DU5051Z</b>							
Picture Mode	pic.mode	V	V				0:Presentation 1:Bright 2:Game 3:Movie 4: Golf 5: Blending 6: sRGB 7:DICOM SIM 8:User 9: 3D 10: HDR 10
Brightness	bright	V	V	V	V		0 ~ 100
Contrast	contrast	V	V	V	V		0 ~ 100
HDR Control	hdr.control	V	V				0 : Auto 1 : Off 2 : HDR 10
HDR Mode	hdr.mode	V	V				0 : PQ-L300 1 : PQ-L400 2 : PQ-L500
Dynamic Black	dblack	V	V				0 = Off 1 = On
"Projector Light (Light Off Timer)"	projector.light	V	V				0 : Disable 1: 1 Sec 2: 2 Sec 3: 3 Sec 4: 4 Sec
HSG/Red Gain	hsg.r.gain	V	V	V	V		5 ~ 195
HSG/Green Gain	hsg.g.gain	V	V	V	V		5 ~ 195
HSG/Blue Gain	hsg.b.gain	V	V	V	V		5 ~ 195
HSG/Cyan Gain	hsg.c.gain	V	V	V	V		5 ~ 195
HSG/Magenta Gain	hsg.m.gain	V	V	V	V		5 ~ 195
HSG/Yellow Gain	hsg.y.gain	V	V	V	V		5 ~ 195
HSG/Red/Saturation	hsg.r.sat	V	V	V	V		0 ~ 199
HSG/Green/Saturation	hsg.g.sat	V	V	V	V		0 ~ 199
HSG/Blue/Saturation	hsg.b.sat	V	V	V	V		0 ~ 199

Function	Operation	Set	Get	Inc	Dec	EXE	Values
HSG/Cyan/Saturation	hsg.c.sat	V	V	V	V		0 ~ 199
HSG/Magenta/Saturation	hsg.m.sat	V	V	V	V		0 ~ 199
HSG/Yellow/Saturation	hsg.y.sat	V	V	V	V		0 ~ 199
HSG/Red/Hue	hsg.r.hue	V	V	V	V		-99 ~ 99
HSG/Green/Hue	hsg.g.hue	V	V	V	V		-99 ~ 99
HSG/Blue/Hue	hsg.b. hue	V	V	V	V		-99 ~ 99
HSG/Cyan/Hue	hsg.c. hue	V	V	V	V		-99 ~ 99
HSG/Magenta/Hue	hsg.m. hue	V	V	V	V		-99 ~ 99
HSG/Yellow/Hue	hsg.y. hue	V	V	V	V		-99 ~ 99
HSG/White/Red Gain	hsg.wr.gain	V	V	V	V		0 ~ 399
HSG/White/Green Gain	hsg.wg.gain	V	V	V	V		0 ~ 399
HSG/White/Blue Gain	hsg.wb.gain	V	V	V	V		0 ~ 399
Brilliant Color	bri.color	V	V	V	V		0 ~ 10
Sharpness	sharp	V	V	V	V		0 ~ 31
Gamma	gamma	V	V				0 = 1.8 1 = 2.0 2 = 2.2 3 = 2.4 4 = B&W 5 = Linear
Color Temperature	color.temp	V	V				0 = Warm 1 = Normal 2 = Cold
Input Balance /Red Offset	red.offset	V	V	V	V		-100 ~ +100
Input Balance /Green Offset	green.offset	V	V	V	V		-100 ~ +100
Input Balance /Blue Offset	blue.offset	V	V	V	V		-100 ~ +100
Input Balance /Red Gain	red.gain	V	V	V	V		0 ~ 200
Input Balance /Green Gain	green.gain	V	V	V	V		0 ~ 200
Input Balance /Blue Gain	blue.gain	V	V	V	V		0 ~ 200
Picture Mode Reset	pic.mode.reset	V					0 = Current 1 = All
Aspect Ratio	aspect	V	V				0 = Fill 1 = 4:3 2 = 16:9 3 = LetterBox 4 = 21.9:1 5 = 16:10 6 = Auto
Digital Zoom	digi.zoom.in	V	V	V	V		0 ~ +10
	digi.zoom.out	V	V	V	V		-40 ~ 0
H Image Shift	img.hshift	V	V	V	V		-192 ~ +192
V Image Shift	img.vshift	V	V	V	V		-120 ~ +120
V Keystone	v.keystone	V	V	V	V		-30 ~ +30
H Keystone	h.keystone	V	V	V	V		-30 ~ +30
4 Corner Top Left X	4corner.tlx	V	V	V	V		0 ~ +200 0~+720*
4 Corner Top Left Y	4corner.tly	V	V	V	V		0 ~ +200 0~+1280*
4 Corner Top Right X	4corner.trx	V	V	V	V		0 ~ +200 0~+720*
4 Corner Top Right Y	4corner.try	V	V	V	V		0 ~ +200 0~+1280*
4 Corner Bottom Left X	4corner.blx	V	V	V	V		0 ~ +200 0~+720*

**Note:**  
 "\*" for DK5153Z only.

Function	Operation	Set	Get	Inc	Dec	EXE	Values
4 Corner Bottom Left Y	4corner.bly	V	V	V	V		0 ~ +200 0~+1280*
4 Corner Bottom Right X	4corner.brx	V	V	V	V		0 ~ +200 0~+720*
4 Corner Bottom Right y	4corner.bry	V	V	V	V		0 ~ +200 0~+1280*
Mask Top	mask.top	V	V	V	V		0 ~ 100
Mask Bottom	mask.bottom	V	V	V	V		0 ~ 100
Mask Left	mask.left	V	V	V	V		0 ~ 100
Mask Right	mask.right	V	V	V	V		0 ~ 100
Projection	projection	V	V				0 = Front 1 = Rear 2 = Ceiling 3 = Rear + Ceiling
Screen Format	screen.format	V	V				0 : 16:10 1 : 16:9 2 : 4:3 3: 21.9:1
Screen Position	screen.shift	V	V	V	V		16:10 : Not Available 16:9 : -60 ~ 60 4:3 : -160 ~ 160 21.9:1 : -191 ~ 191
Alignment Reset	align.reset					V	
Test Pattern	test.pattern	V	V				0 = Grid 1 = White 2 = Red 3 = Green 4 = Blue 5 = Black 6 = RGB Ramps 7 = Color Bar 8 = Setp Bar 9 = CheckBoard 10 = Horizontal Lines 11 = Vertical Lines 12 = Diagnoal Lines 13 = Horizontal Ramps 14 = Vertical Ramps 15 = Off
Direct Power On	direct.poweron	V	V				0 : Off 1 : On
Signal Power On HDMI	signal.poweron.hdmi	V	V				0 : Off 1 : On
Light Mode	light.mode	V	V				0: Normal 1: ECO 1: Silent* 2: Custom Light
Custom Light	custom.light	V	V	V	V		25 ~ 100
Fan Speed	fanspeed	V	V				0 = Normal 1 = High
IR Control	ir.control	V	V				0 : Front + Rear IR On 1 : Front IR On 2 : Rear IR On 3 : Front + Rear IR Off
Remote ID	remote.id	V	V				0 ~ 7

**Note:**

“\*” for DK5153Z only..

Function	Operation	Set	Get	Inc	Dec	EXE	Values
HDMI1 EDID	edid.mode.hdmi1	V	V				0 : Enhanced 1 : Standard
HDMI2 EDID	edid.mode.hdmi2	V	V				0 : Enhanced 1 : Standard
HDBaseT EDID	edid.mode.hdbt	V	V				0 : Enhanced 1 : Standard
NetWork Status	net.status		V				0 : Disconnect 1 : Connected
NetWork / DHCP	net.dhcp	V	V				0 = Off 1 = On
NetWork / IP Address	net.ipaddr	V	V				<string>
NetWork / Subnet	net.subnet	V	V				<string>
NetWork / Gateway	net.gateway	V	V				<string>
NetWork / DNS	net.dns	V	V				<string>
NetWork Apply	net.apply	V					0 : Cancel 1 : OK
Standby Power	standby.power	V	V				0: Normal 1: ECO 2: On By Lan 3: On By HDBaseT
No Signal Power Off	nosignal.poweroff	V	V				0 ~ 36
Sleep Timer	sleep.timer	V	V				0 ~ 120
Volume	volume	V	V	V	V		0 ~ 10
Constant Brightness	laser.cbc.enable	V	V				0 : Off 1 : On
Blank Screen Color	blankscreen.color	V	V				0 = Logo 1 = Black 2 = Red 3 = Green 4 = Blue 5 = White
Logo	logo	V	V				0 = Std. 1 = Black 2 = Blue
Message	message	V	V				0 : Off 1 : On
MENU Position	menu.position	V	V				0 : Center 1 : Up 2 : Down 3 : Left 4 : Right
MENU Timer	menu.timer	V	V				0 : Off 1 : 20 sec. 2 : 40 sec. 3 : 60 sec.
MENU Translucent	menu.trans	V	V				0 : Off 1 : 50% 2 : 100%
Keypad Lock	keypad.lock	V	V				0 : Off 1 : On
Security Lock	security.lock	V	V				1 : Up 2 : Down 3 : Left 4 : Right
Security Unlock	security.unlock	V					1 : Up 2 : Down 3 : Left 4 : Right

Function	Operation	Set	Get	Inc	Dec	EXE	Values
Language	lang	V	V				0 = English 1 = French 2 = German 3 = Spanish 4 = Portuguese 5 = Simplified Chinese 6 = Traditional Chinese 7 = Italian 8 = Norwegian 9 = Swedish 10 = Dutch 11 = Russian 12 = Polish 13 = Finnish 14 = Greek 15 = Korean 16 = Hungarian 17 = Czech 18 = Turkish 19 = Japanese 20 = Danish 21 = Thai
Reset All	reset.all					V	
Source Info	source.info		V				<string>
Light Hours 1	light1.hours		V				<string>
Software Version	sw.ver		V				<string>
Serial Number	ser.no		V				<string>
Auto Image	auto.img					V	
Light 1 Status	light1.stat		V				0 = Off 1 = On
Model	model		V				<string>
Pixel Clock	pixel.clock		V				<string>
H Refresh Rate	h.refresh		V				<string>
V Refresh Rate	v.refresh		V				<string>
Blank	blank	V	V				0 = Off 1 = On
Power On	power.on					V	
Power Off	power.off					V	
Projector Status	status		V				0 : Reset 1 : Standby 2 : Active 3 : Cooling 4 : Warmup 5 : Powerup 6 : Failure
Mute	mute	V	V				0 : Off 1 : On
Freeze	freeze	V	V				0 : Off 1 : On
Internal Speaker	speaker	V	V				0 : Off 1 : On
Input Select	input.sel	V	V				6: HDMI 1 9: HDMI 2 15: HDBaseT (Optional)

## 8. Services

### Europe, Middle East and Africa

Vivitek Service & Support  
Zandsteen 15  
2132 MZ Hoofddorp  
The Netherlands  
Tel: Monday - Friday 09:00 - 18:00  
English (UK): 0333 0031993  
Germany: 0231 7266 9190  
France: 018 514 8582  
Russian: +7 (495) 276-22-11  
International: +31 (0) 20 721 9318  
Email: [support@vivitek.eu](mailto:support@vivitek.eu)  
URL: <http://www.vivitek.eu/support/contact-support>

### North America

Vivitek Service Center  
15700 Don Julian Road, Suite B  
City of Industry, CA. 91745  
U.S.A  
Tel: 855-885-2378 (Toll-Free)  
Email: [T.services1@vivitekcorp.com](mailto:T.services1@vivitekcorp.com)  
URL: [www.vivitekusa.com](http://www.vivitekusa.com)

### Asia and Taiwan

Vivitek Service Center  
16 Tungyuan Rd., Chungli Industrial Zone,  
Taoyuan City 320023, Taiwan  
320023桃園市中壢區東園路16號4樓  
Tel: 886-3-4526107  
Tel: 0800-042-100  
Email: [srv-Service.VVK.Asia@vivitek.com.tw](mailto:srv-Service.VVK.Asia@vivitek.com.tw)  
URL: [www.vivitek.com.tw](http://www.vivitek.com.tw)

### 中国/China

Vivitek客服中心  
上海市浦东新区华东路1675号1幢1层、7-8层  
邮政编码: 201209  
400客服热线: 400 888 3526  
公司电话: 021-58360088  
客服邮箱: [service@vivitek.com.cn](mailto:service@vivitek.com.cn)  
官方网站: [www.vivitek.com.cn](http://www.vivitek.com.cn)



Visit [www.vivitekc corp.com](http://www.vivitekc corp.com) for more product info  
Copyright (c) 2024 Delta Electronics, Inc. All Rights Reserved

A brand of  DELTA