



User's Manual

DU9900Z

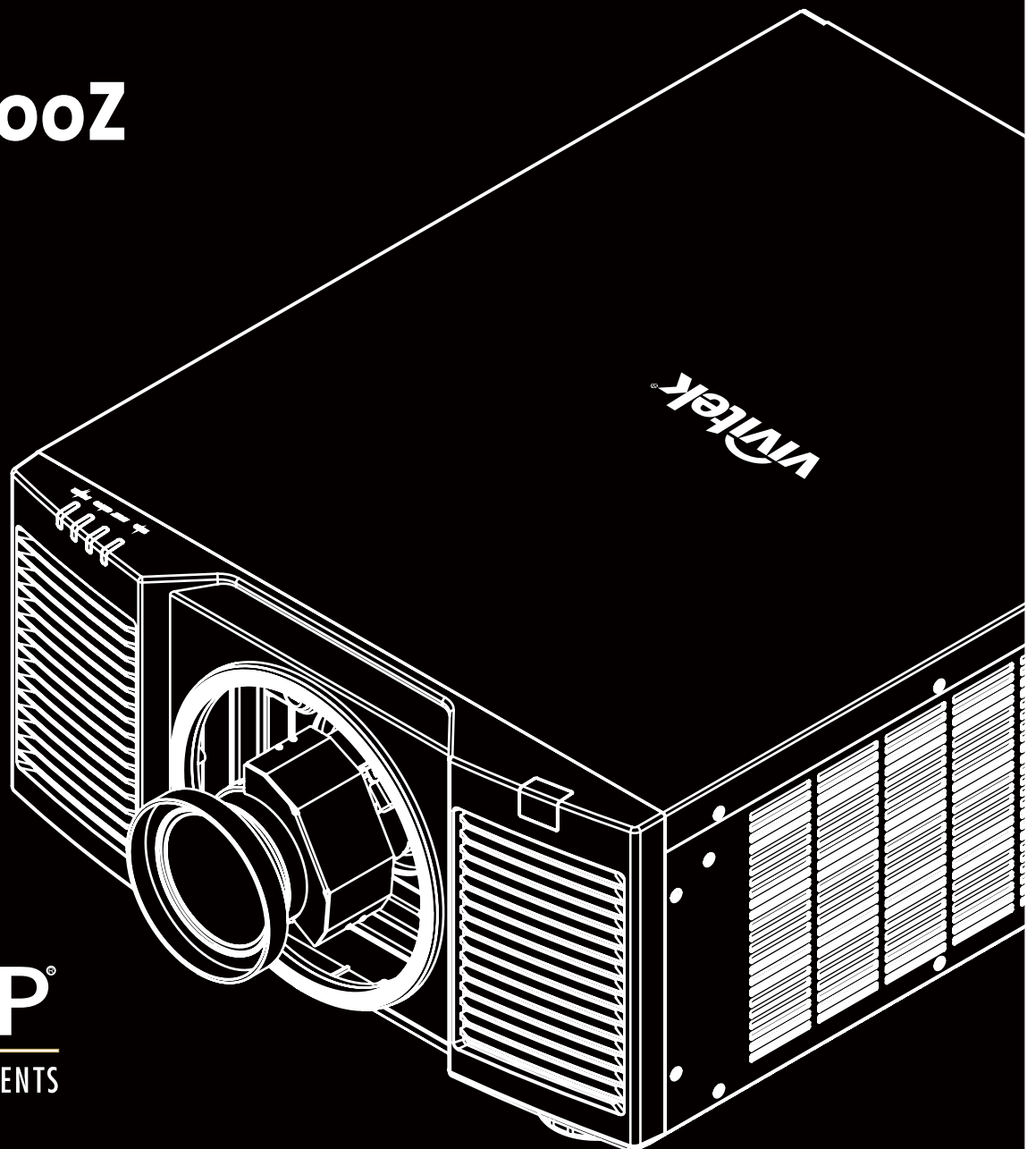

Table of Contents

Copyright	3
Copyright	3
Disclaimer	3
About the Manual	3
Important Safety Guidelines	4
Safety Notification	4
Installation and Use Notices	6
Disposal of Old Electric and Electronic Equipment	6
Important Recycling Instructions	6
Introduction	7
Packing Checklist	7
Projector Overview	8
IO Panel	10
Control Panel	11
Remote Control	12
Installation and Setting up	14
Inserting or Changing the Remote Control Batteries	14
Installing the Projector	15
Precautions for Installation	15
Mounting the Projector	15
Installing or Removing the Optional Lens	17
Connecting to AC Power Supply	19
Turning On the Projector	19
Turning Off the Projector	20
Adjusting the Projection Mode	21
Adjusting the Projected Image Position	22
Adjusting the Focus and Zoom	22
Adjusting Geometric Distortion	23
Keystone	23
Rotation	24
Pincushion / Barrel	24
Arc	25
Top-Left Corner	26
Top-Right Corner	26
Bottom-Left Corner	27
Bottom-Right Corner	27
Custom Warp	27
Preventing Unauthorized Use of the Projector	28
Using the Control Panel Lock	28
Using the Security Lock	29
Using Control ID for Multi-Projector Application	31
Using the Constant Brightness Function to Maintain the Brightness Output	33
Connecting Equipment	34
Connecting a Computer	34
Connecting a Video Device	34
Connecting to a Control Equipment	34
Connecting a Screen Trigger	36
Connecting an HDBaseT Transmitter	37
Using the Projector	38

Using On-Screen Display	38
Using the On-Screen Display.....	38
Menu Tree	39
INPUT	39
PICTURE	39
ALIGNMENT	40
CONTROL	41
SERVICE	43
OSD Menu – INPUT.....	44
OSD Menu – PICTURE.....	47
OSD Menu – ALIGNMENT.....	49
OSD Menu – CONTROL.....	52
OSD Menu – SERVICE.....	56
Product Specification.....	57
Supported Signal Input Timing	58
Configurations of Terminals.....	61
DU9900Z Lens Series	62
Product Dimensions	63
LED Indication	64
Common Problems and Solutions.....	65
About the Vivitek Support.....	67

Copyright

Copyright

The User's Manual (including all pictures, illustrations and software) is protected by the international copyright law. All rights are reserved. No duplication of the manual or any content included in the manual is allowed without the written consent of the manufacturer.

© Copyright 2021 Vivitek. All rights reserved. Vivitek is a trademark of Delta Electronics, Inc.

Disclaimer

The information in the manual is subject to change without notice. The manufacturer does not provide any statement or warranty of the contents in the manual and clearly give up the implied warranties of merchantability and of fitness for a particular purpose. The manufacturer reserves the rights to modify the publication and change the contents of the materials at any time without notice to any person.

About the Manual

The manual describes how to install and use the projector and is applicable to the purchaser of this projector. Relevant information (such as illustrations and descriptions) is put on the same page and accurate as much as possible the format, easy for printing, is convenient for reading and paper-saving which is beneficial to environmental protection. It is suggested to print only the page you need.

Important Safety Guidelines

Thank you for purchasing this high quality product!

Read the Manual carefully to obtain the best performance. The Manual provides instructions on how to use the menu and implement the operation.

Safety Notification

CAUTION To turn off the main power, ensure to unplug from the power outlet.



CAUTION To prevent electric shock, do not open the cabinet. There are high-voltage components inside.



Refer service to qualified service personnel.

CAUTION The symbol warns the user about electric shock caused by voltage not insulated. Therefore, it is dangerous to make any kind of contact with any parts inside the projector.



CAUTION To prevent the projector from electrical discharge or electric shock, do not expose the projector to rain or moist environment. Do not use the plug with an extension cord or an outlet unless all the prongs can be fully inserted.



This symbol alerts the user that important information which should be read carefully to avoid problems concerning the operation and maintenance of the projector.

WARNING TO CALIFORNIA RESIDENTS:

Handling the cables supplied with this equipment might expose user to a little lead, a chemical known to the State of California, resulting in risks of barrenness. Please remember to wash hands after handling.

NOTIFICATION (CANADA)

This Class A digital equipment complies with Canadian ICES-003.

CE NOTIFICATION

This is a Class A product, which complies with rules for CE marking. This product may cause radio interference that the user may be supposed to take adequate measures.

FCC NOTIFICATION

This device complies with part 15 of the FCC Rules. The operation is subject to the following two conditions:

(1) This device may not cause harmful interference;

(2) This device must accept any interference received, including interference that may cause undesired operation. This equipment has been tested and found to comply with part 15 of the FCC Rules. These requirements are designed to provide reasonable protection against harmful interference when the equipment operates in a commercial environment. This equipment might generate radio frequency energy. If user does not install or use in accordance with the instructions in manual, the radio frequency energy may interfere radio reception. If the above scenario occurs, the user may be responsible for correcting the interference



WARNING!

Changes or modifications without approval from Vivitek could void the user's authorization to operate the product.

LIGHT MODULE

- A light module containing multiple laser diodes acts as the light source in the product.
- These laser diodes are sealed in the light module. It is recommended to ask dealer for maintenance or repair services of the light module.
- The end user is not allowed to replace the light module.
- Contact distributor who provides the qualified service for light module replacement and further information.

LASER SAFETY NOTIFICATION AND CAUTION



Do not stare at the lens while in use

- CLASS 3R LASER PRODUCT
- This Laser Product is designated as Class 3R during all procedures of operation.
- LASER LIGHT - AVOID DIRECT EYE EXPOSURE.
- Do not point laser or allow reflected laser light toward other people or reflective objects.
- Direct or scattered light can be hazardous to eyes and skin.
- There is a potential hazard of eye exposure to laser radiation if the included instructions are not followed.
- Caution – use of controls, adjustments or performance of procedures other than those specified herein may result in hazardous radiation exposure.

Laser Parameters:

Wavelength	: 450nm - 460nm	Total internal power	: >100W
Mode of operation	: Pulsed, due to frame rate	Apparent source size	: >10mm, at lens stop
Pulse width	: 0.7ms	Divergence	: >100 mili Radian
Maximum laser energy	: 0.39mJ		

Product Label

Manufacturer's ID Label, Explanatory Label and Certification Statement Label

Hazard Warning Symbol and Aperture Label

Installation and Use Notices

1. Read and keep this manual properly.
2. Pay attention to all the noted warnings, and follow all the guidelines and descriptions in this manual.
3. Do not use the projector near water.
4. Do not install the equipment near the thermal sources, such as heaters, radiators, furnace, amplifiers, and any other equipment that may generate heat.
5. Be careful while holding the equipment or moving the trolley with projector to prevent the equipment from turning over.
6. Notice whether there is any parts with flaws after receiving the projector.
7. Please notice that the projector will not power on until the lens is fitted. The protection covering the lens should be taken to install the lens.
8. Do not let any vent be obstructed.
9. Do not destroy the safety protection function of polarized or grounding plug of the power cord. A polarized plug has one wide and one narrow blade. The plug has two blades and one grounding blade. The wide blade or grounding blade is provided for the safety concerns. If the plug provided does not match the outlet, please contact the electrician to change outlet.
10. The +12V trigger only outputs 12V DC trigger signal. Do not connect other power input or output. Otherwise, the equipment may malfunction.
11. Adjust the slide switch with suitable volt input, and then plug in the projector; the red LED indicator would flash and then stabilize, getting into standby mode. User should only use the connectors or accessories provided by the manufacturer.
12. When user turns on the projector, the red LED indicator would flash until stabilized. Do not look at the lens directly while the projector is running.
13. Unplug the power cord of the equipment if there is a thunderstorm or the equipment is not going to be used for an extended period of time.
14. It is suggested to properly keep the packaging materials for future transportation or afterservice.
15. If any breakdown occurs, please contact dealer or manufacture for qualified repair service.



Disposal of Old Electric and Electronic Equipment

The symbol on your product or the package represents that the product should not be treated as the normal household waste when discarded but should be carried to the recycling location of the waste electric and electronic equipment. The consequence on the environment and human health due to the incorrect disposal of the product can be prevented if it can be ensured that the product is properly discarded. Material recycling is helpful to the protection of natural resources. The symbol is only valid in the European Union. If you want to discard electrical and electronic equipment, contact the governmental authorities or your dealer for the correct method of disposal.

Important Recycling Instructions

The product may contain other electronic wastes and may pose risk if not discarded properly. Abide by the local, state/provincial or federal laws of recycling or discarding. For more information, please visit the website and contact Electronic Industries Alliance (EIA) on WWW.EIAE.ORG.

Projector Overview

Front-left View

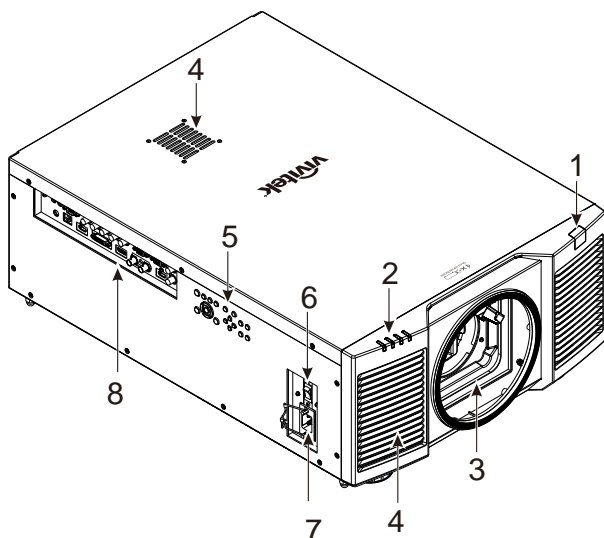

1. **Front IR Receiver**
The Receiver is for IR signals from the remote control.
2. **LED Indicator**
Display current projector status such as power, light source status and warning.
3. **Lens Mounting Hole**
The mounting hole is for installing the projection lens.
4. **Air Intake**
The fan pulls the cool air to the projector for system cooling.
5. **Control Panel**
Press the button to operate the OSD menu or adjust the lens Settings see OSD controls.
6. **AC Power Switch**
Turn on/off the AC power of the projector.
7. **AC Inlet**
Connect the supplied power cable to this inlet.
8. **I/O Connector Panel**
Connect to various input, control or output terminals to the projector.
9. **Lens Release Button**
Press the Lens Release button before removing the lens.
10. **Height Adjuster**
Adjust level of projector
11. **Intake Vent**
The fans pull air to cool the radiator of the projector.

Front-right View

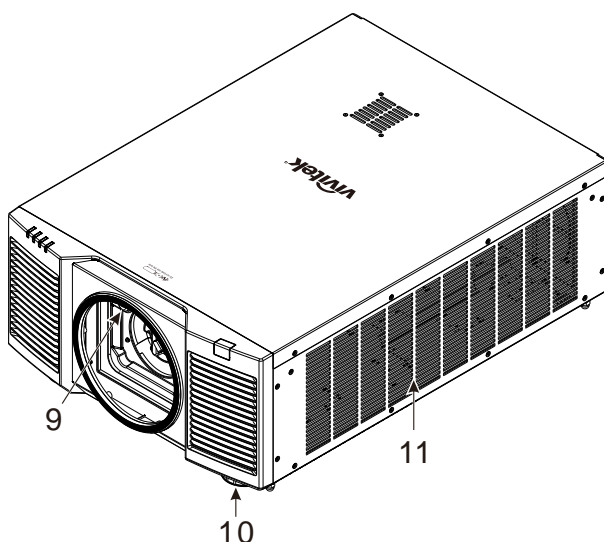

Rear View

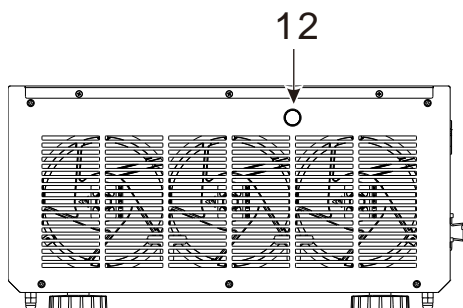

12. **Rear IR Receiver**
The Receiver is for IR signals from the remote control.



Important:

- Air passes through the projector's grill openings to ensure good air circulation and to keep the projector running smoothly. Do not obstruct any of the grill openings and keep the required distance from any object.

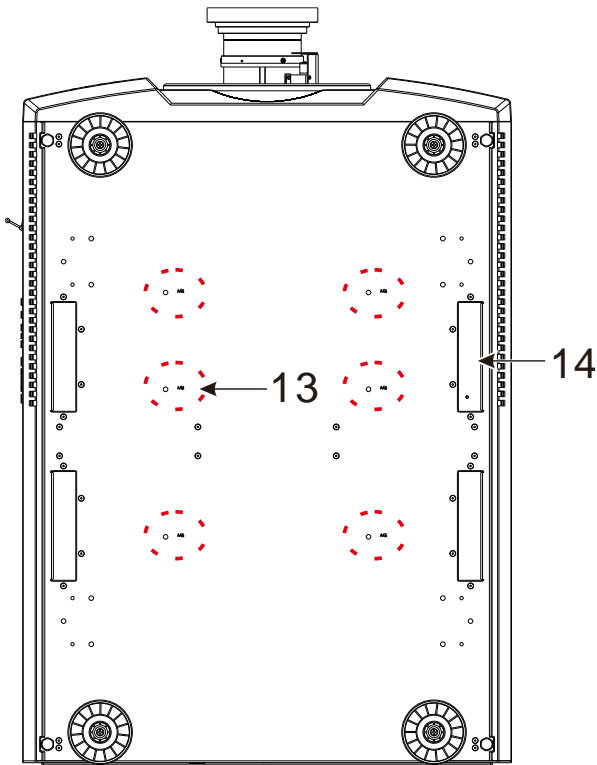
Bottom View**13. Ceiling Mounting Hole**

Total, six M6 screw holes with maximum depth of 16mm

14. Recess for projector handling.

These four recesses can be used for handling the projector.

**Caution:**

- When installing, ensure that you use only UL Listed ceiling mounts. Contact your dealer for information on mounting the projector on a ceiling.
- With ceiling installation, use approved mounting hardware & M6 screws; maximum depth of screw is 16 mm.

IO Panel

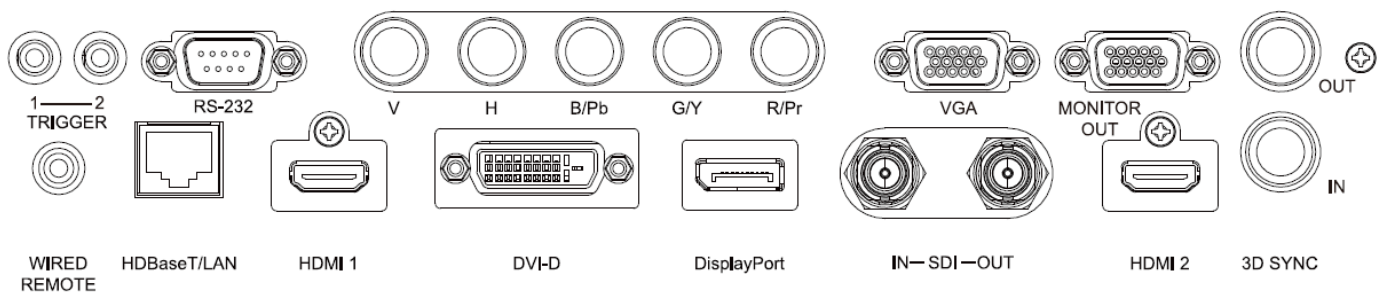

TRIGGER (12V +/-1.5V)

When connected to the screen through a 3.5mm cable, the screen deploys automatically on startup of the projector. The screen reacts when the projector is powered off.

RS-232

The 9-pin D-sub interface is used to connect to the PC control system and projector maintenance.

Component (V, H, B/Pb, G/Y, R/Pr)

Connect RGBHV or Component signal from computer or component video enabled device

VGA

Provide the standard 15-pin VGA connection and can connect to RGB, HD Component or personal computer.

MONITOR OUT

Connect to a monitor to display the projected content.

WIRED REMOTE

Connect the supplied remote controller to the projector

HDBaseT/LAN

Connect an Ethernet cable (Cat5/Cat6, not supplied) from a computer, network device, or HDBaseT transmitter.

HDMI 1

Connect the HDMI cable from a computer or video device

DVI-D

Connect to DVI-D cable from a DVI-D output of the device.

DisplayPort

Connect the DisplayPort cable from a computer or video device.

SDI IN/OUT

Connect to SDI source.

HDMI 2

Connect the HDMI cable from a computer or video device

3D SYNC IN / Out

Connect to the 3D IR synchronization signal transmitter.



Note for Trigger

- When the projector is turned on, a control output signal (DC 12V) is delivered from this terminal.
- Do not use this jack for anything other than intended use.



Note for Wired Remote

- Please make sure whether the port for insertion is correct before the terminal of the wired remote control is inserted. The remote control may be damaged if inserted to the wrong port such as trigger. Do not use this jack for anything other than intended use.

Control Panel

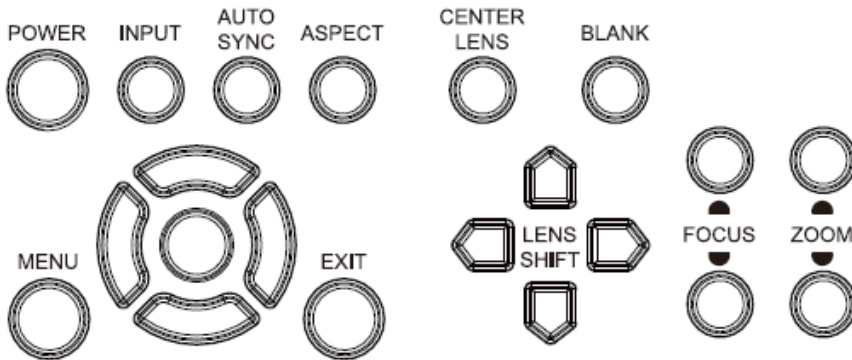

POWER

User the button to turn on/off the projector.

INPUT

Push the button to select the input signal. HDMI, DVI, VGA, Component...etc.

AUTO SYNC

Implement automatic signal synchronization.

ASPECT

Change the aspect ratio of the current image and push the button to change to the next aspect ratio settings.

MENU

Push the button to display or hide the OSD menu.

UP/Down/Left/Right

Use the button to select the OSD option.

ENTER

Use the button to select settings or confirm the changed settings.

EXIT

Push the button to return to the menu on the previous level or exit the OSD menu.

CENTER LENS

Push the button to center the lens and calibrate the parameter of lens shift.

Note: The lens position needs to be calibrated for the accurate lens shift operation after installing the lens. Please center the lens every time after the lens is mounted.

Blank

Use the button to stop the projection temporarily

LENS SHIFT

Use these four buttons to move the projected image to the desired position.

FOCUS

Use the button to adjust the focus of the projected image.

ZOOM

Use the button to zoom in/out the projected image.

Remote Control

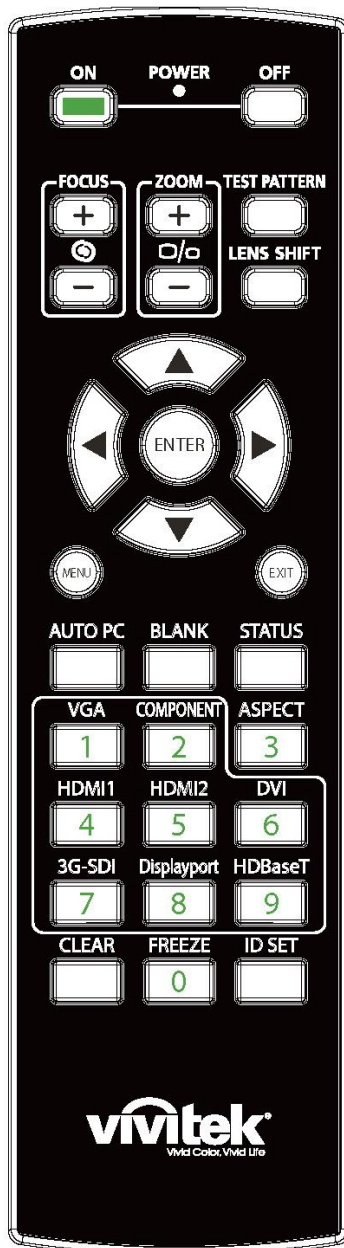

On

Use the button to turn on the projector.

OFF

Use the button to turn off the projector.

FOCUS

Adjust the focus of the projected image.

ZOOM

Zoom in/out the projected image.

TEST PATTERN

Use the button to show the test pattern. Press this button again to switch to the next pattern. Press the EXIT button to return to the projected image.

LENS SHIFT

Use the button to move the lens right or left.

ENTER

Use the button to select settings or confirm the changed settings.

MENU

Press the button to display or hide the OSD Menu.

EXIT

Press the button to return to the previous Menu or exit the OSD Menu.

AUTO PC

You can use this function to execute signal source auto synchronization

BLANK

Press the button to temporarily interrupt the projection.

STATUS

Show OSD MENU – SERVICE.

VGA

Select VGA as the input source.

COMPONENT

Select Component as input source.

ASPECT

Press the button to display aspect ratio options.

HDMI1

Select HDMI 1 as the input source.

HDMI2

Select HDMI 2 as the input source.

DVI

Select DVI-D as the input source.

**Wired Remote Jack**

Connect to WIRED REMOTE terminal on the projector

3G-SDI

Select 3G-SD as the input source.

DisplayPort

Select DisplayPort as input source.

HDBaseT

Select HDBaseT the input source.

CLEAR

Erase the set ID number of the remote control; refer to the section "Using Control ID for Multi-projector Application".

FREEZE

Freeze the projected image or resume the projection.

ID SET

Set up ID number for remote control; refer to the section "Using Control ID for Multi-projector Application".

Remote Control Operating Range

The remote control uses the infrared transmission to control the projector. It is not necessary to point the remote directly at the projector. Provided you are not holding the remote perpendicular to the sides or the rear of the projector, the remote will function well within a radius of about 10 meters (25 feet) and 15 degrees above or below the projector level. If the projector does not respond to the remote control, move a little closer.

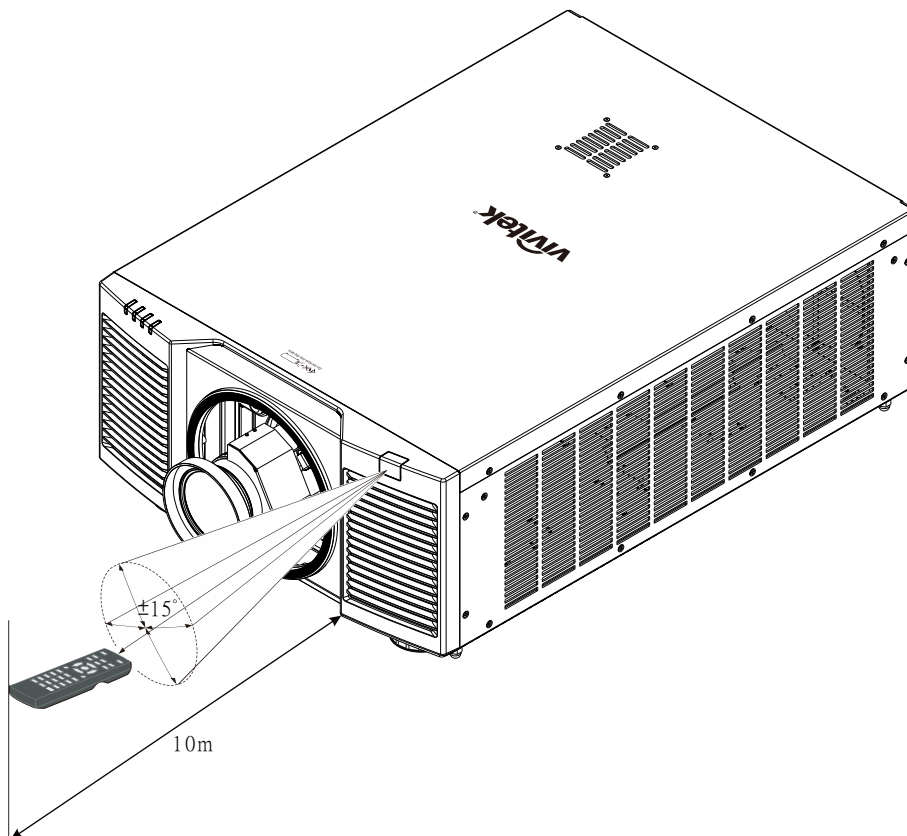

Installation and Setting up

Inserting or Changing the Remote Control Batteries

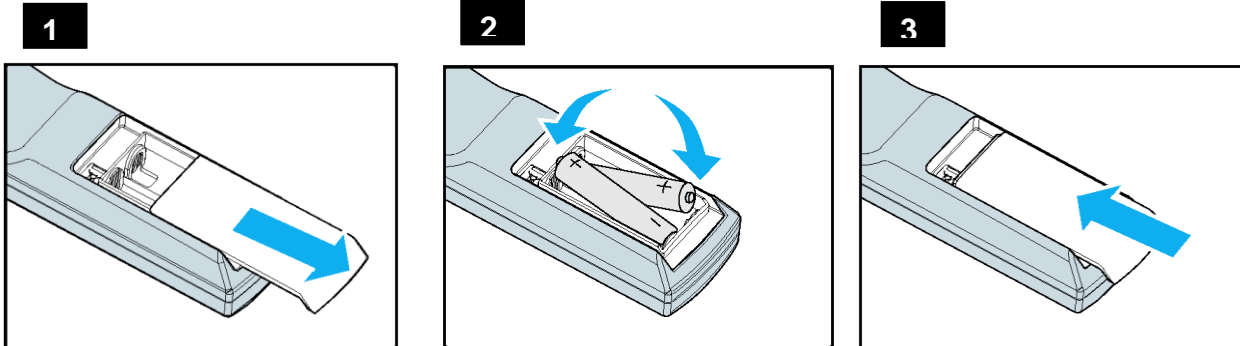

1. Remove the battery compartment cover by sliding the cover in the direction of the arrow.
2. Place two AA batteries with the correct polarity.
3. Replace and slide the cover as like the arrow in the illustration.

**Important:**

- Avoid using the projector with bright fluorescent lighting turned on. Certain high-frequency fluorescent lights can disrupt remote control operation.
- Be sure nothing obstructs the path between the remote control and the projector.
- Do not expose the remote control to high temperature or humidity; otherwise, the remote control will not function correctly.

**Battery installation instructions**

- Make sure the battery is installed with the correct polarity.
- Do not use the old and new batteries or the batteries of different types together.
- Remove the battery if the remote control is not being used for long periods of time to prevent damage caused by battery leakage.

Installing the Projector

The high quality display effect can be guaranteed only when the projector is correctly installed. Generally, the light source facing the screen should be reduced or eliminated as much as possible. The contrast of the image will be obviously reduced if the light directly shines on the screen, such as the beam from windows or the searchlight cast on the image. The image may become faded and not bright.

Precautions for Installation



Caution:

- Projector installation must be done by a qualified professional. Contact your dealer for more information. It is not recommended you install the projector yourself.
- With ceiling installation, use approved mounting hardware & M6 screws; maximum depth of screw is 16 mm. Contact your dealer for information about mounting the projector on a ceiling.
- Only use the projector on a solid and level surface. Serious injury and damage can occur if the projector is dropped.



Caution:

- Ensure that the hot air from the exhaust vent is not sucked into the projector.
- Ensure the air intake and exhaust vents are unobstructed and keep the required distance from any object. Below is required minimum distance between the vent and any object.
- All added enclosures should pass a certified thermal evaluation to ensure that the projector does not recycle exhaust air, as this may cause the projector to shut down even if the enclosure temperature is within the acceptable operation temperature range.

Airflow and Heat Emission

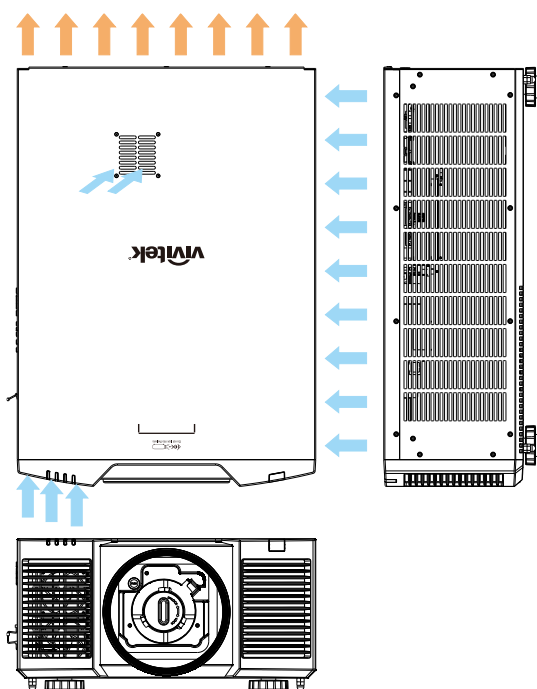

Minimum Distance to Vent

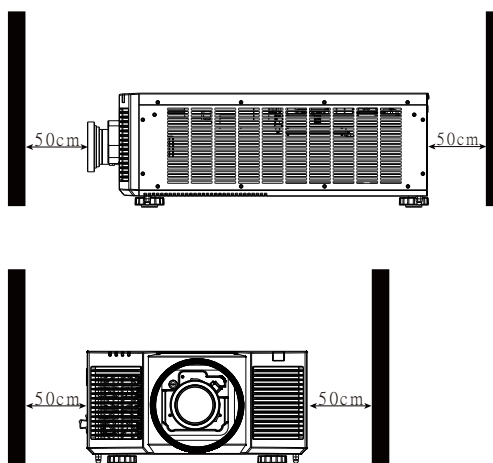

Caution:

- Only use the projector on a solid and level surface. Serious injury and damage can occur if the projector is dropped.
- Please do not stack the projector on the surface of another projector. Serious injury and damage may occur if the projector is dropped.

Mounting the Projector

For mounting the projector, please use UL Listed ceiling mounts and M6 screws, maximum depth of screw is 16 mm.

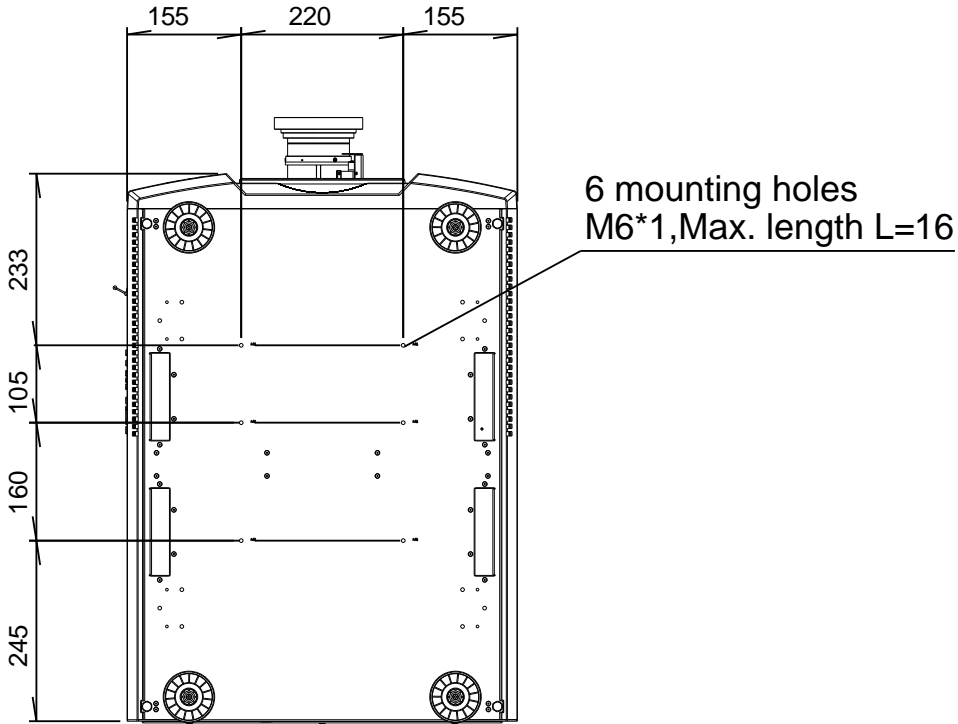

Installing or Removing the Optional Lens



Caution:

- Do not shake or place excessive pressure on the projector or the lens components as the projector and lens components contain precision parts.
- When shipping the projector with the optional lens, remove the optional lens before shipping the projector. The lens and the lens shift mechanism may encounter damage caused by improper handling during transportation.
- Before removing or installing the lens, be sure to turn off the projector and wait until the cooling fans stop, and turn off the main power switch.
- Do not touch the lens surface when removing or installing the lens.
- Keep fingerprints, dust or oil off the lens surface. Do not scratch the lens surface.
- Work on a level surface with a soft cloth under the projector to avoid scratches or other damage.
- If you remove and store the lens, attach the lens cap to the projector to keep out dust and dirt.

Install New Lens

1. If the Lens cover is installed, rotate the lens cap counterclockwise until it disengages (①), and slowly pull the lens out (②)

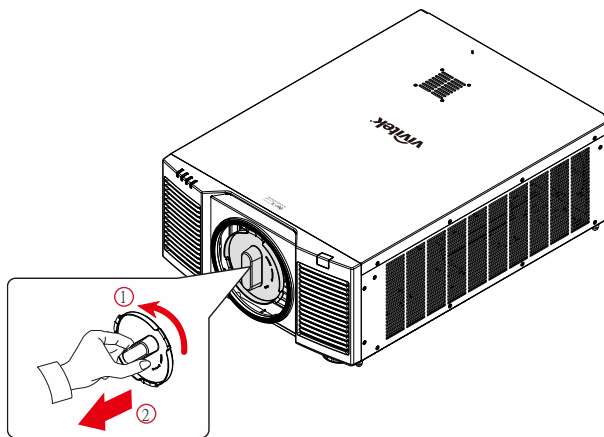

2. Push the lens into the lens mounting hole (③) and turn it clockwise to the "Lock" position (④). When turning the lens, the "Click" sound indicates that the lens is completely fixed and locked in place.

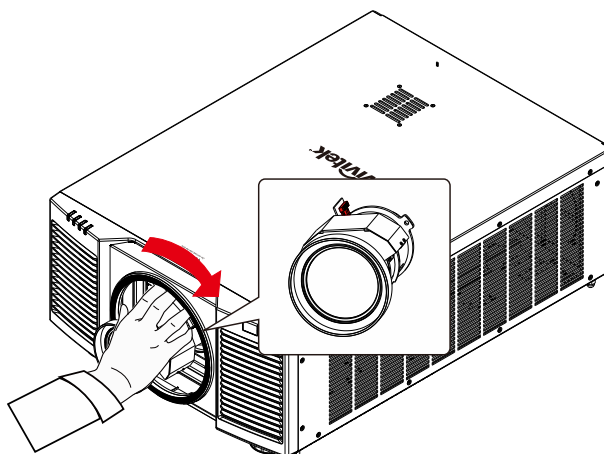

3. Check if the lens is fixed successfully by pulling the lens out of the holder gently.

Removing the Existing Lens

1. Push the LENS RELEASE button all the way in and rotate the lens counterclockwise. The existing lens will be disengaged

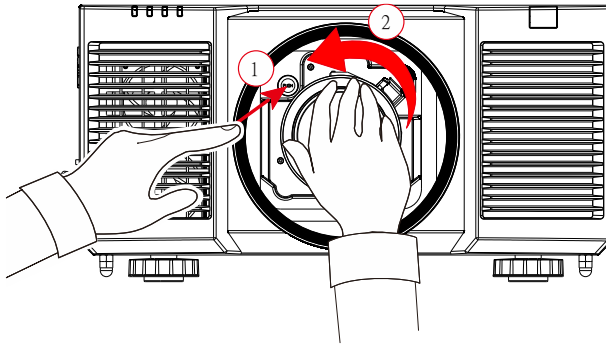

2. Pull out the existing lens slowly.

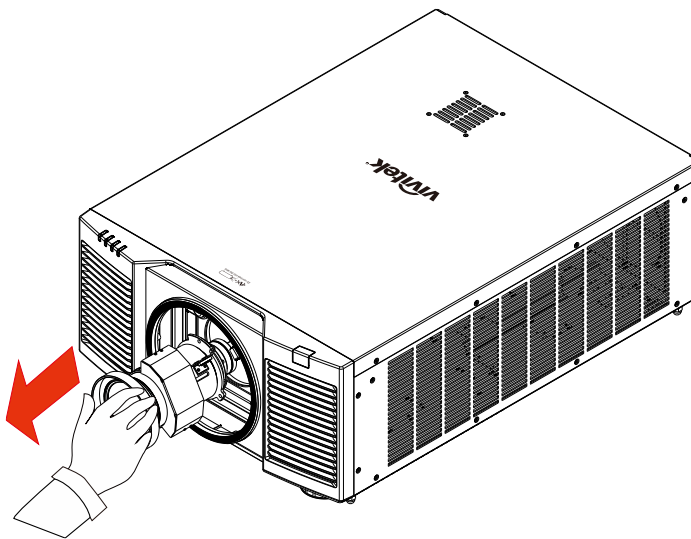

Important:

- When installing the lens into the projector, be sure to remove the lens cap from the back of the optional lens before installing the optional lens into the projector. Failure to do so will cause damage to the projector and lens.
- There is one safety switch inside the projector's lens slot to prevent unexpected injury by laser beam. The projector cannot be turned on if the projection lens has not been installed or is not installed correctly. Please make sure the lens is installed properly before tuning on the projector.

Connecting to AC Power Supply

The AC power cord is included in the box; plug the power cord to the AC socket on the IO panel.

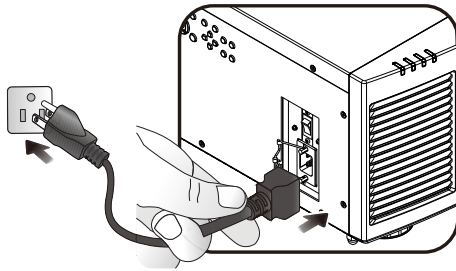

Important:

- When the input voltage is 110V, the current supplied by the power supply does not provide the current required to run the projector at full power. In this case, the projector will automatically reduce the light source power to 65%, and the projector light output will also be reduced to about 65% of the nominal brightness accordingly to ensure that the projector can operate normally

Turning On the Projector

Once the projector is correctly located and the power cable and other connections are in place, it is important that the projector is powered on correctly in order to avoid damage to components and un-necessary wear and tear. Refer to the following guide to power on the projector.

1. Press the main power switch to the on (I) position as shown. POWER LEDs will flash, then turn a solid red.

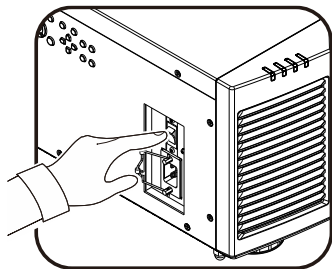

2. Press the POWER button on the control panel or ON button on the remote control.

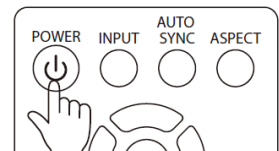
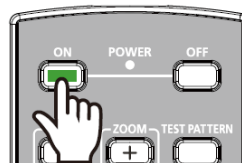

3. The Power LED and LIGHT LED flashes green until the power on process is finished.

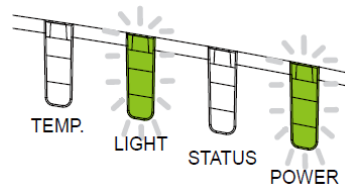

4. After a few seconds, both LEDs lights will become a solid green to indicate the projector is ready for use.

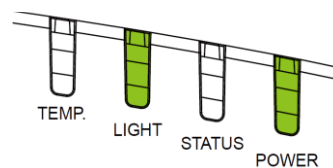

Turning Off the Projector

Once the projector is no longer required, it is important to shut it down correctly to avoid damage or unnecessary wear and tear on the device.



Important:

- Do not unplug the power cable from the wall outlet or projector when the projector is powered on. Doing so can cause damage to the projector's AC IN connector or the prongs of the power cable plug. To turn off the AC power supply when the projector is powered on, use a power strip equipped with a power on switch and surge protector.
- Do not turn off the AC power supply within 10 seconds after making adjustment or changing the setting. Doing so is possible to cause loss of adjustments and settings and return to default

Refer to the following guide to shut down the projector.

1. Press the POWER button on the control panel or OFF button on the remote control once, the Power Off window displays.

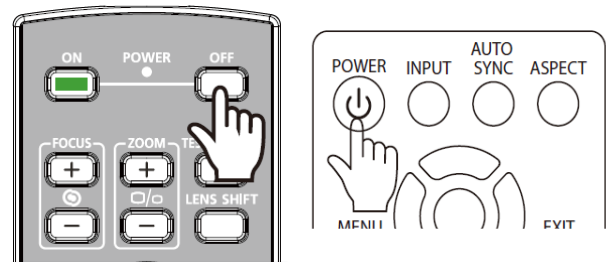

2. Press the POWER button again on the OSD control panel or remote control to verify power off, the power LED flashes orange after Power Off is confirmed.
3. The projector enters Standby mode when the power LED light is red.
4. Press the Main Power switch to the off position (O) to turn off the projector.

Power Off?
Press Power again

Adjusting the Projection Mode

DU9900Z is designed for set up in all angles including desktop, ceiling, portrait and free-tilt installation as shown in the below illustration.

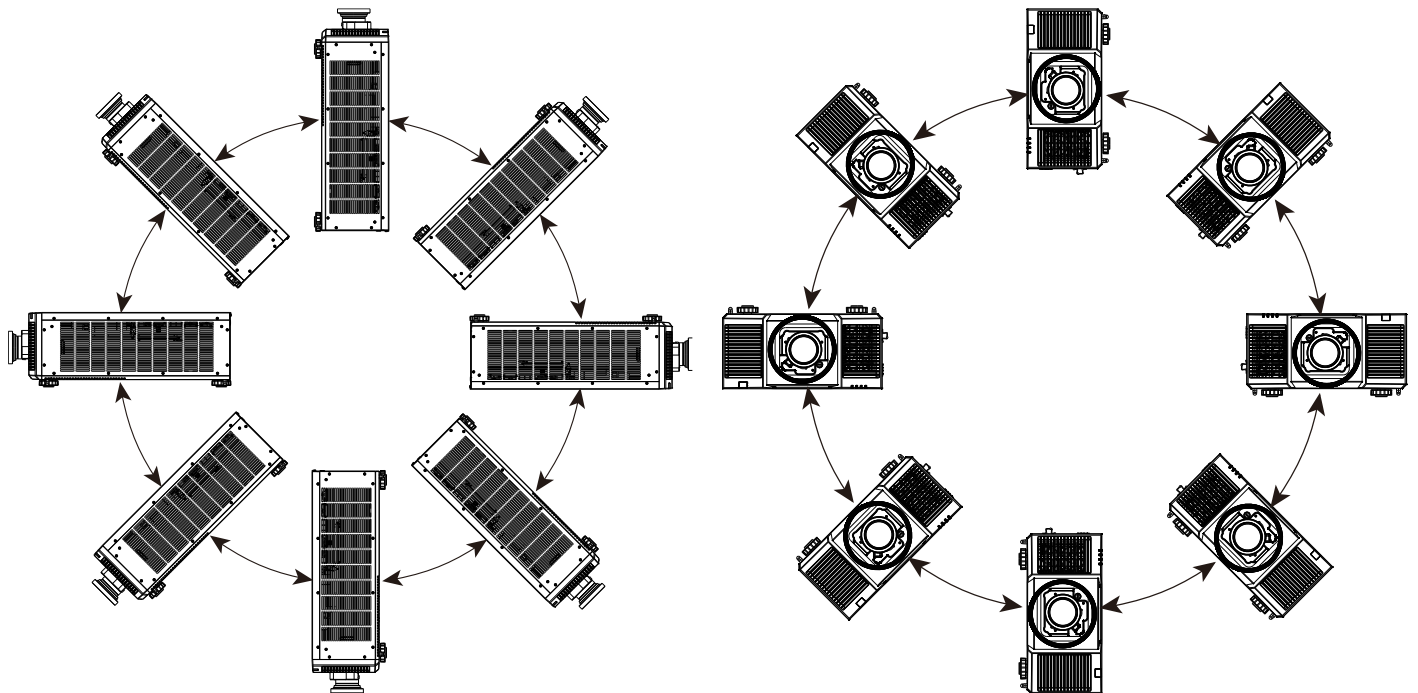

You can change the direction of the image using the Projection Mode. The projector has a smart cooling mechanism, which regulates the fan automatically according to the projection mode.

INPUT	PICTURE	ALIGNMENT	CONTROL	SERVICE
Language			English	← / ▶
Projection Mode			Auto	← / ▶
High Altitude			Auto	← / ▶
Auto Power Off		<	Off	>
Auto Power On		<	Off	>
Network				← / ▶

Use the ◀ or ▶ button to select a projection mode to flip the projected image as installation orientation or viewing direction. The selection options are described as below.

- Auto-Front:** Turn on the orientation sensor to change automatically the direction of the image.
- Front Desktop:** Install the projector on the desktop and project the image forward.
- Rear Desktop:** Install the projector on the desktop and project the image from the rear of the screen.
- Front Ceiling:** Mount the projector on the ceiling and project the image forward.
- Rear Ceiling:** Mount the projector on the ceiling and project the image from the rear of the screen.

Adjusting the Projected Image Position

The DU9900Z projector has the powered lens shift feature; the image can be shifted vertically or horizontally without moving the projector. The lens shift range is shown in the percentage of the image height and width, the maximum vertical shift range can be up to 50% of the projected image height and down to 50% of the height, and maximum horizontal shift range is 15% of the image width to right and left. Please refer to below illustration.

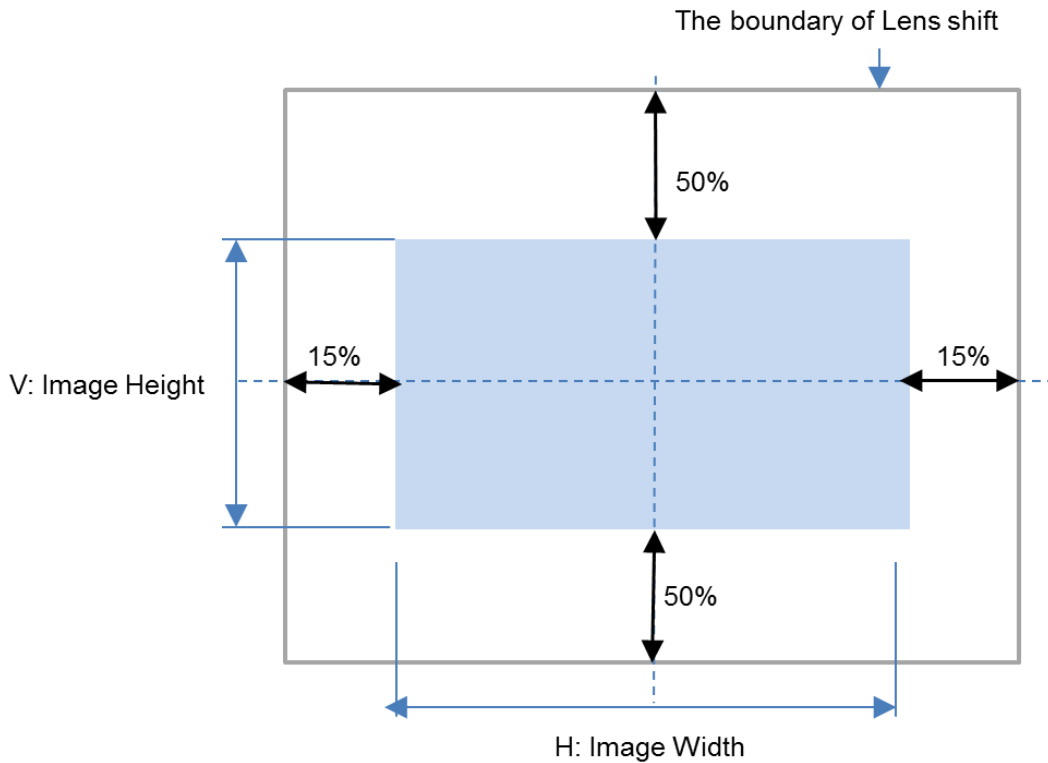

Note:

- The projector is equipped with a safety switch inside the lens mount hole. The projection lens must be installed in the projector before turning on the power or the projection can't be displayed.
- There is a Lens Lock function on OSD menu to disable lens control adjustment for avoiding possible misoperation after you finish the adjustment. Please make sure to disable the lock before performing the lens control.

Adjusting the Focus and Zoom

The focus and zoom can be adjusted from the projector control panel or remote control. Refer to the following guides to adjust the focus and zoom manually.

Press the Focus or Zoom button on the control key panel or remote control to adjust the focus or zoom effect using the increase and decrease buttons as required

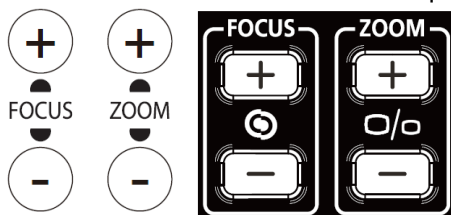

Adjusting Geometric Distortion

When the image is projected on a curved surface or screen at an angle, the image may become distorted. You can utilize the latest Vivitek Geometric Correction engine to make an image look visually correct when it is projected onto a non-planar screen or at an angle. The option as below figure, the available function combination is listed on the submenu of each geometry correction option.

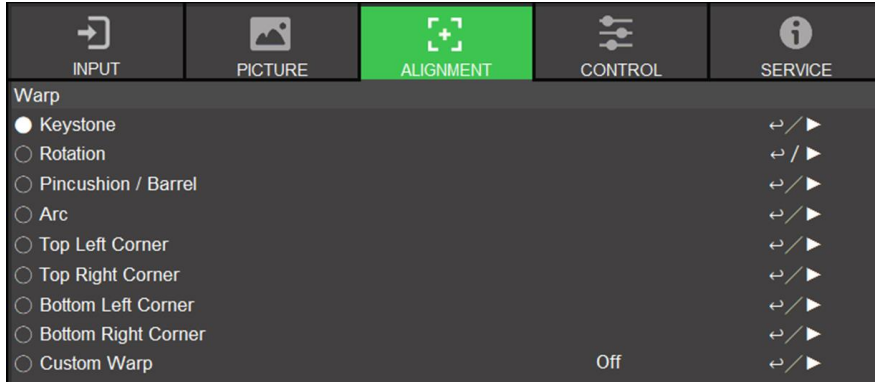

Keystone

Select the Keystone adjustment then use the ◀ or ▶ button to correct the distortion, the adjustable value in horizontal and vertical correction is ± 30 . The illustration is as below.

Horizontal Keystone:

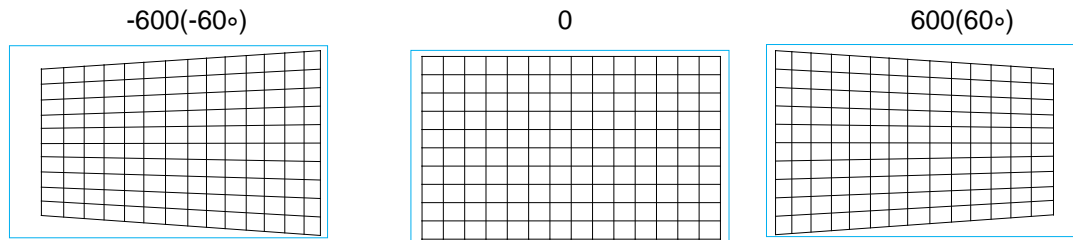

Vertical Keystone:

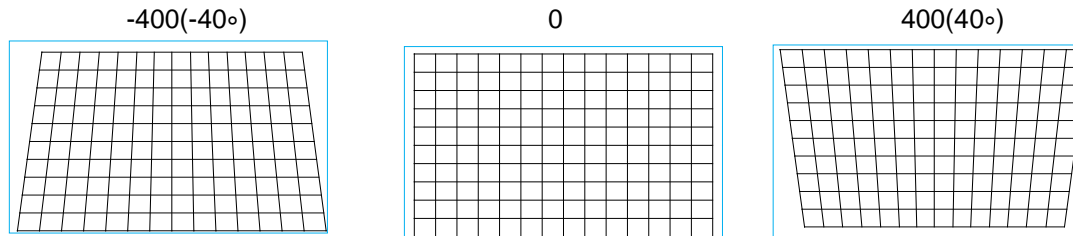

Besides correcting H and V Keystone by separate, you can use H and V keystone combination to correct the distortion. In this case, the effective range may be limited.



Note:

- Above adjustable range is for the case you adjust single dimension, the adjustable range of H and V Keystone combination is narrow if comparing with single- dimension adjustment.

Rotation:

After H or V Keystone is adjusted, Rotation option is available for rotating the image if required. The option is only available if H or V Keystone is adjusted, Use the ◀ or ▶ button to rotate the image clockwise or counterclockwise,

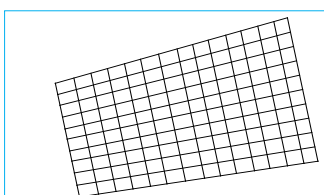

Reset:

Reset all of settings under this option to the default value.

Rotation

Rotate the projected image within active display area.

Use the ◀ or ▶ button to rotate the image clockwise or counterclockwise. Select Reset option to return Rotation setting to default value. Note that the image size is shrunk for projecting full image when Rotation is enabled; please refer to below illustration for adjustable range.

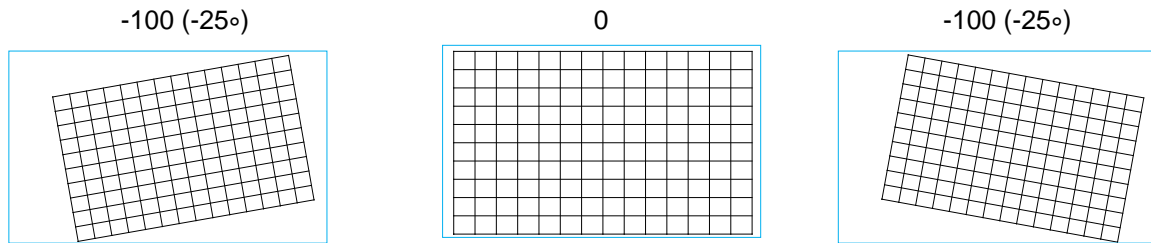

Pincushion / Barrel

When image is projected onto a cylindrical screen or hemispherical domes, you can use Pincushion /Barrel Correction to correct the distortion. Use the ◀ or ▶ button to adjust Pincushion / Barrel effect, Keystone or rotate the image by Rotation option.

Horizontal

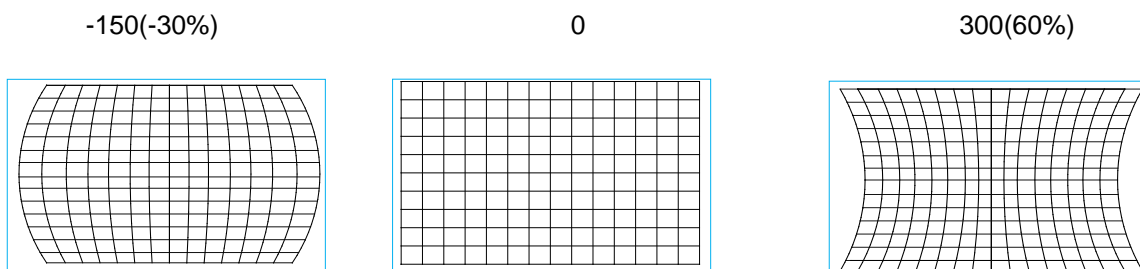

Vertical

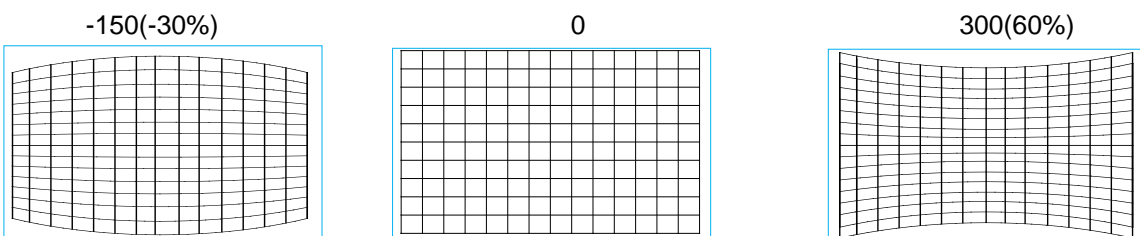

Keystone

Below is an example of using Horizontal Keystone

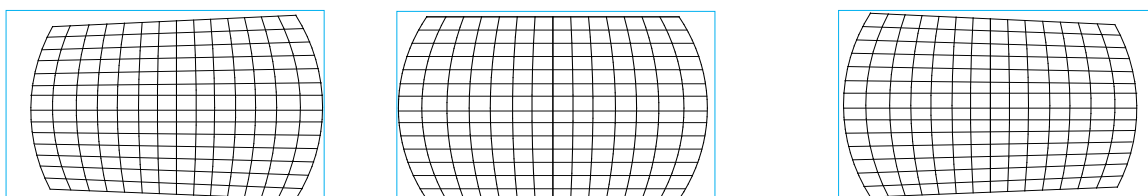

Rotation

Below is an example of using Rotation

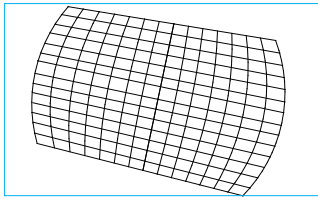

Note:

- H or V Keystone is available when Horizontal or Vertical of Pincushion/Barrel is adjusted.
- Rotation is available when H or V Keystone is adjusted.
- When rotation is adjusted, the image size is shrunk to fit for the active display area.

Arc

Besides correcting the pincushion or barrel effect, ARC function allows you to correct the distortion on one edge. You can separately correct the distortion on top, bottom, left or right of the image. Please refer to below illustrations.

Top

-150 (-30%)

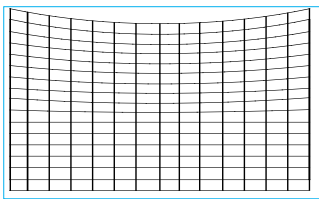

0

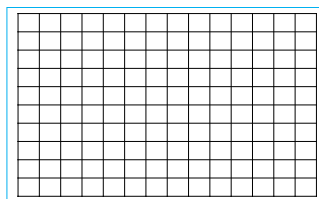

150 (30%)

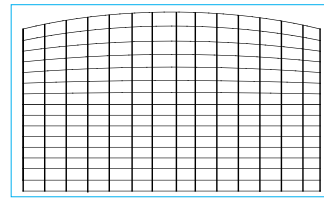

Bottom

-150 (-30%)

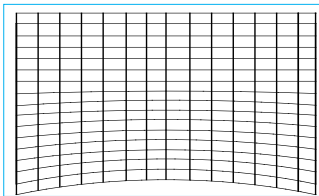

0

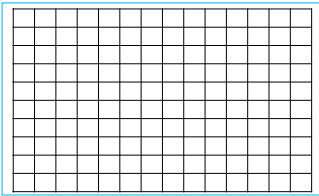

150 (30%)

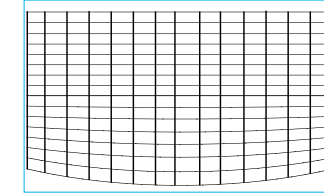

Right

-150 (-30%)

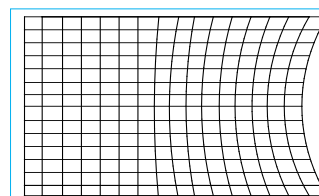

0

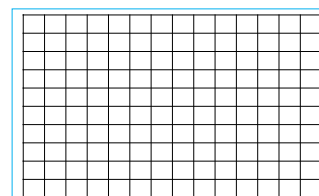

150 (30%)

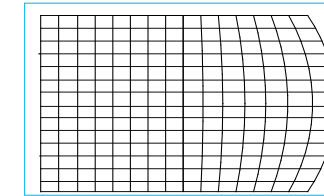

Left

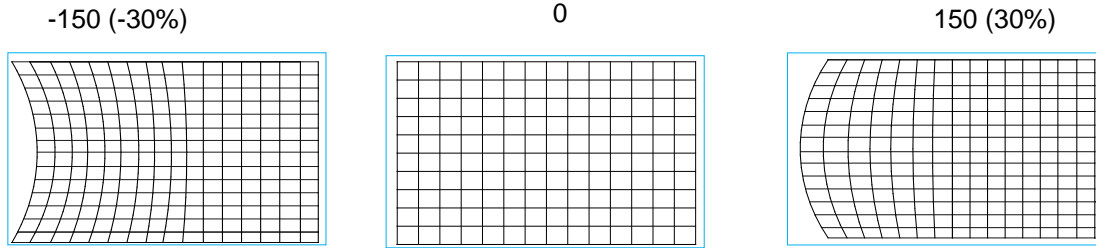

Corner Adjustment

In some applications, the distortion at the corner may occur due to the installation or projected surface.

In this case, you can use Conner adjustment to correct the distortion corner by corner. Please refer to below illustrations

Top-Left Corner

Horizontal

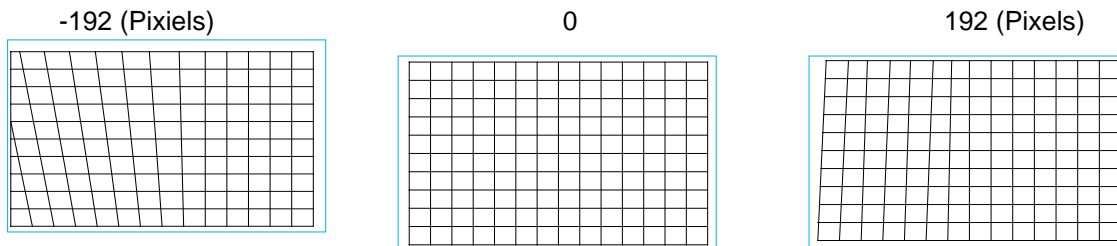

Vertical

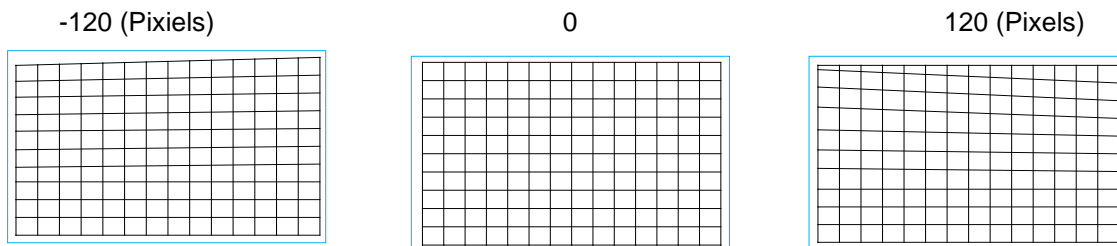

Top-Right Corner

Horizontal

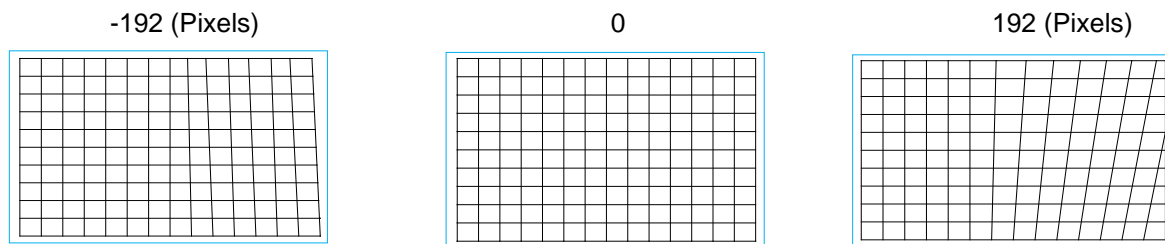

Vertical

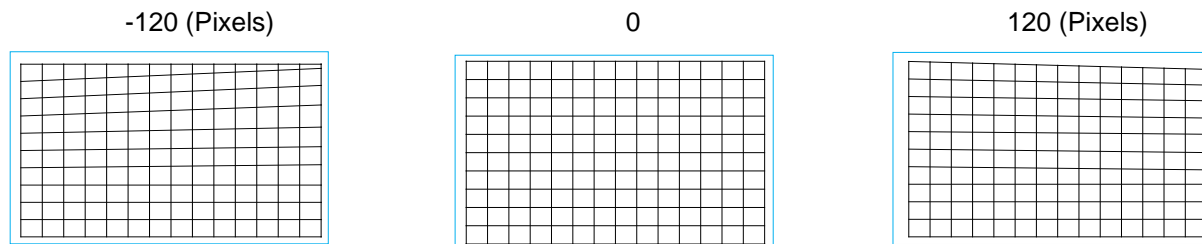

Bottom-Left Corner

Horizontal

-192 (Pixels)

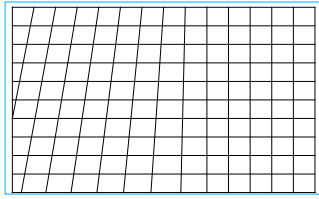

0

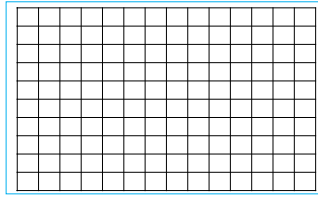

192 (Pixels)

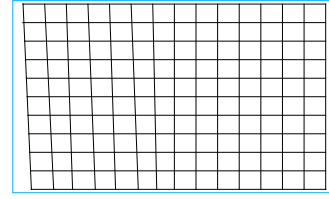

Vertical

-120 (Pixels)

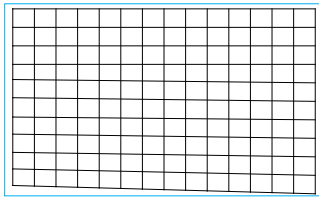

0

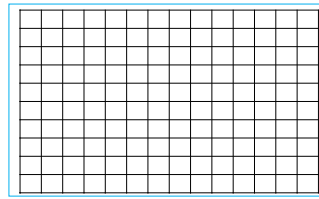

120 (Pixels)

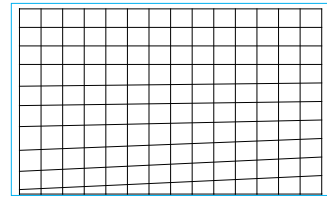

Bottom-Right Corner

Horizontal

-192 (Pixels)

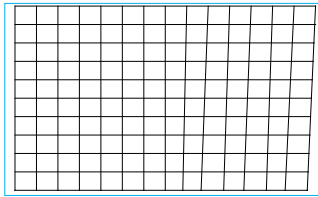

0

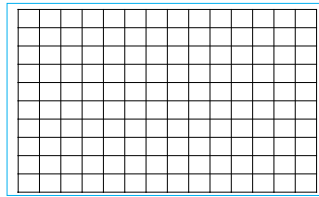

192 (Pixels)

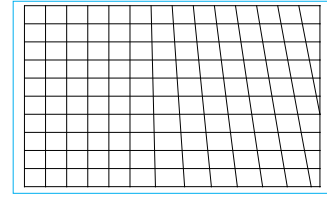

Vertical

-120 (Pixels)

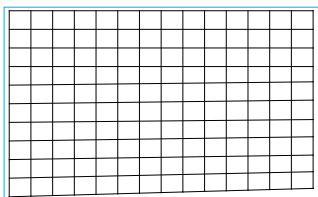

0

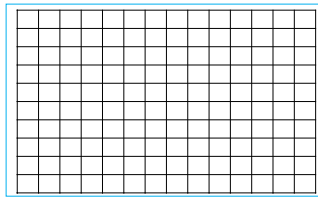

120 (Pixels)

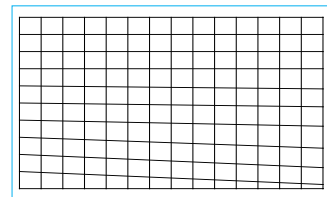

Custom Warp

Apply the geometry adjustment by using vivitek PJ Control (Pro) tool.

Preventing Unauthorized Use of the Projector

Using the Control Panel Lock

This function allows you to lock the control panel on the projector to prevent the unauthorized operation of the control buttons.

Locking the Control Buttons

Select CONTROL->OSD Settings-> Control Panel Lock to enable the function as the below illustration.

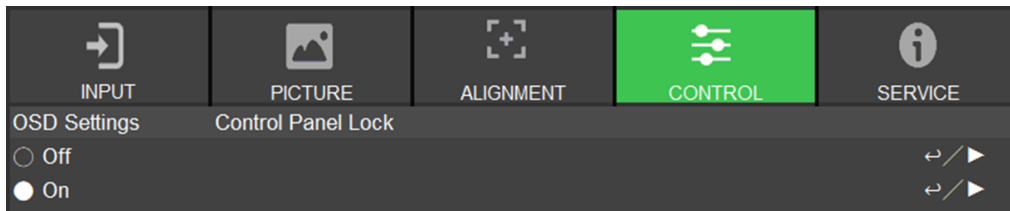
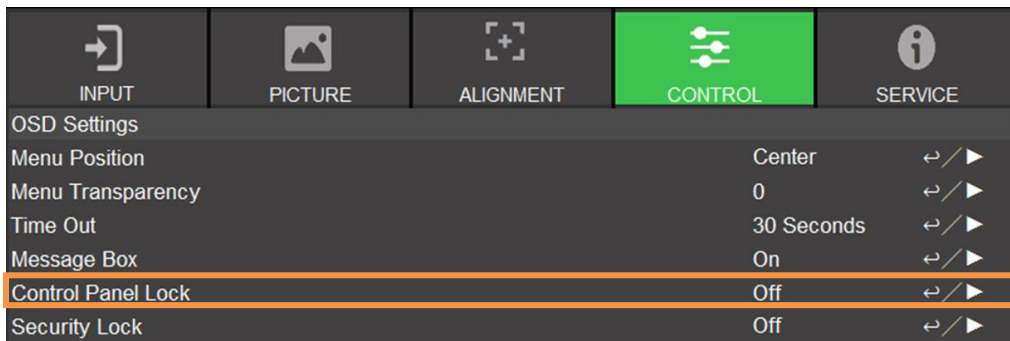

The pop-up message will be shown as below if Control Panel Lock is turned on. Select the OK button to confirm or Cancel to ignore the setting.

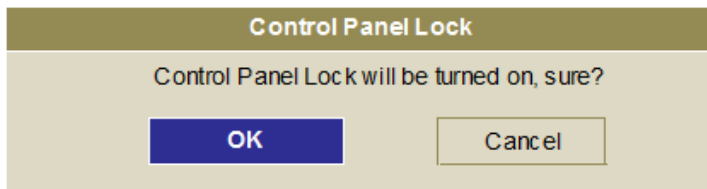

Once the Control Panel Lock is enabled, all the control buttons on the projector are locked. The below message is shown on the screen for several seconds if any control buttons are pressed.



Unlocking the Control Panel

Once Control Panel Lock is enabled, all of control buttons on the projector are disabled. Please enter the OSD option CONTROL>OSD Settings>Control Panel Lock then select Off to unlock the control panel by remote control.

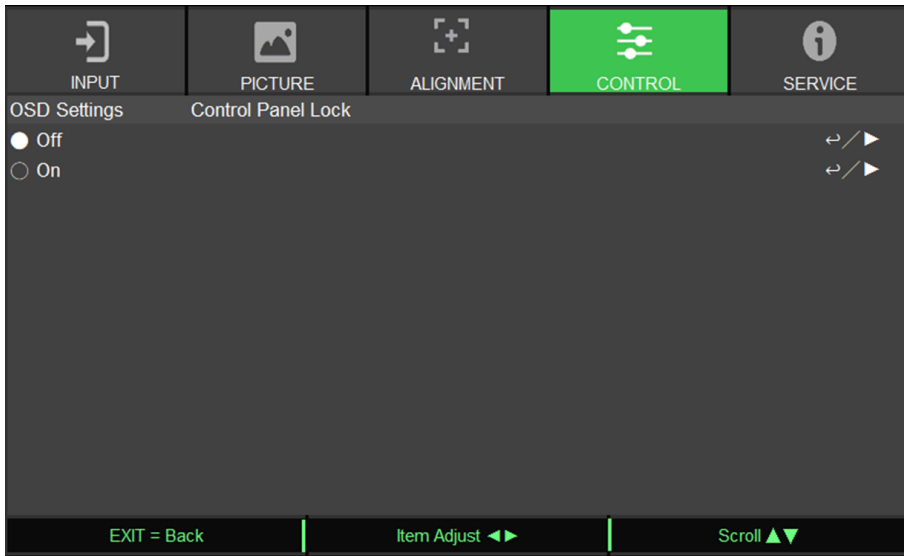

Using the Security Lock

This function allows you to lock the projector for preventing the unauthorized turning on the projector; the setting is valid when you turn on the projector next time.

Enable the Security Lock

Select CONTROL-> OSD Settings-> Security Lock then select On to enable the function as below illustration.

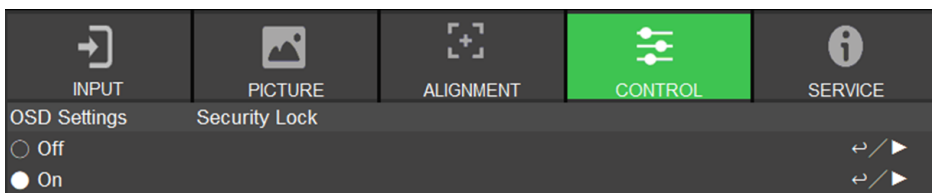
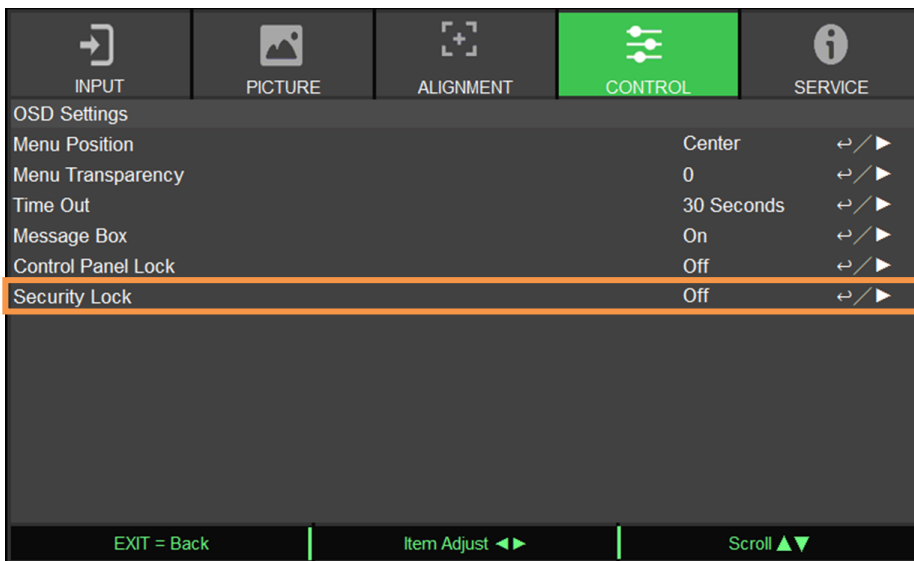

Once Security Lock is turned on, the pop-up message for setting up the password Lock as is shown as below. Press arrow buttons to set up your password, the password can be the combination of four arrow keys.

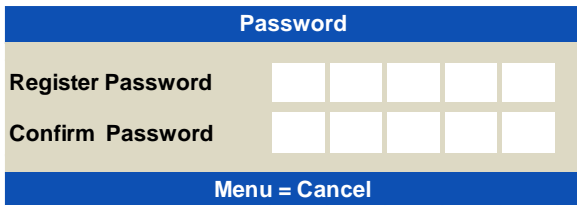

Control Panel Lock is turned on, the pop-up message will be shown Lock as below, select OK to confirm or Cancel to ignore the setting.

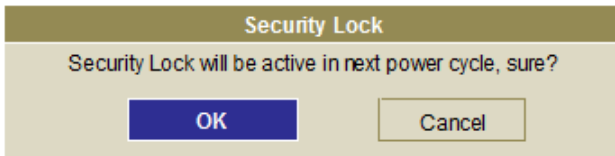

When you turn on the projector next time, the pop-up window will remind you to input the password to start the projection.

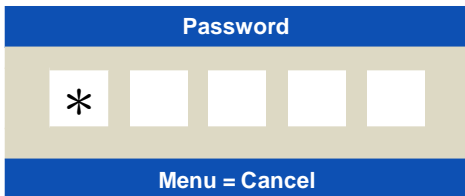

Unlocking the Projector

The projector can be unlocked from the OSD menu, enter CONTROL-> OSD Settings-> Security Lock and select Off to disable Security Lock as the below illustration.

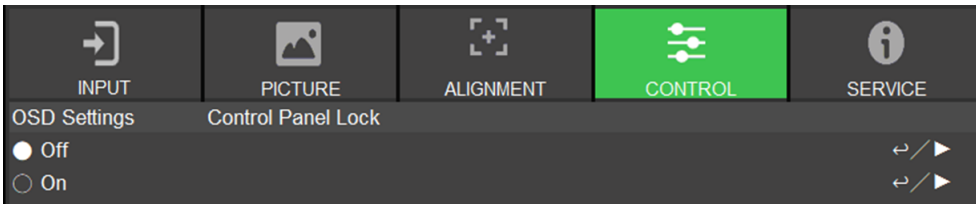

Once the Off option is selected, the pop-up window will be displayed to confirm the setting. Select OK to disable the function, otherwise select Cancel to ignore the setting.

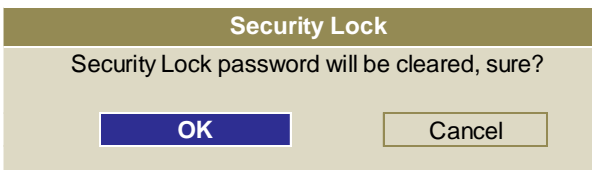

Using Control ID for Multi-Projector Application

When installing more than one projector in the room, the projectors may receive the control signal at the same time. In this case, you can use control ID function to specify the identification of the projector and remote control to operate the specified projector. Follow the below steps to set up the identification number for the projector and remote control.

Set the Projector identification number

1. Enable Projector ID Control function from CONTROL->Infrared Remote->ID Control Enable as below figure.

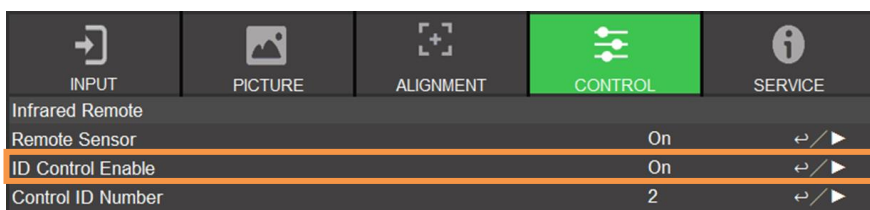
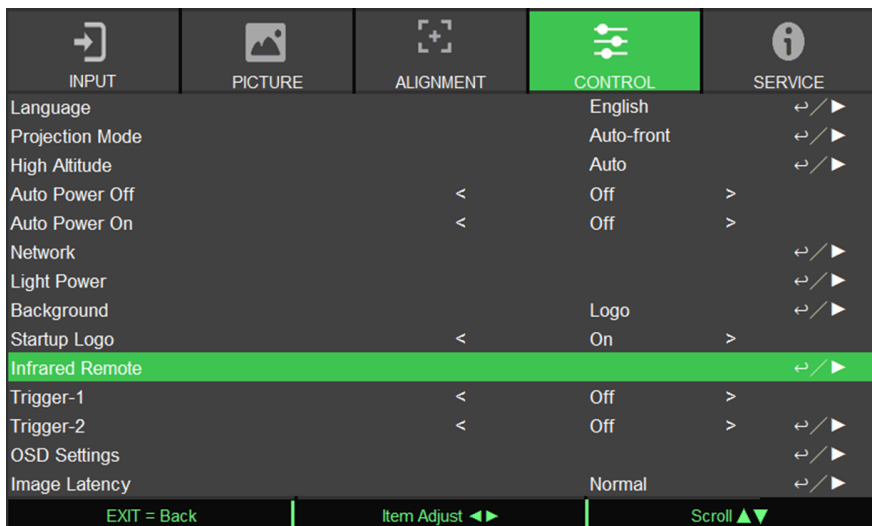

The message box is displayed to confirm enabling ID control after selecting ON option, please OK button to confirm or Cancel button to skip it.

2. Set Control ID Number

Select Control ID Number option then press Enter button, use the ▶ button to increase the number or the ◀ button to decrease the number. This option is available when Projector ID Control is turned on.

Set the identification number of remote control

Press and hold ID SET button on the remote control around 5 seconds, Power LED indicator is flashing red periodically. Press two digits to set desired ID number, each pressing shall be leisurely. Power LED will flash on time when the remote control is confirmed the setting.

Press and Hold ID SET button around 5 seconds

Power LED is flashing

Press two digits for ID number

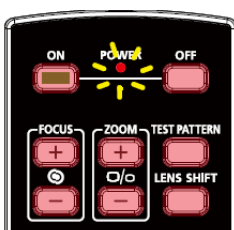
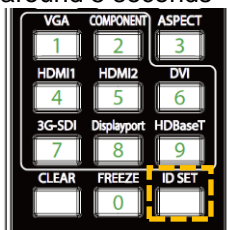

Note:

- Setting the identification number will overwrite the ID number you had set. You can set the ID number directly if you would like to give a new ID number for the remote control.

Erase the identification number of the remote control

The set ID number is overwritten if new ID number is set, you can press ID SET and CLEAR button to erase ID number of the remote control.

Press ID SET and CLEAR buttons simultaneously

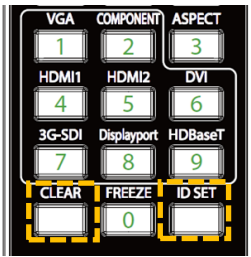

The backlight of the buttons is flashing one time



Checking the identification number of the projector and remote control

The identification number of the projector and remote control can be checked by entering the SERVICE menu as per the below image. "X" represents that the function is not enabled; the number 26 is the current identification number of the remote control

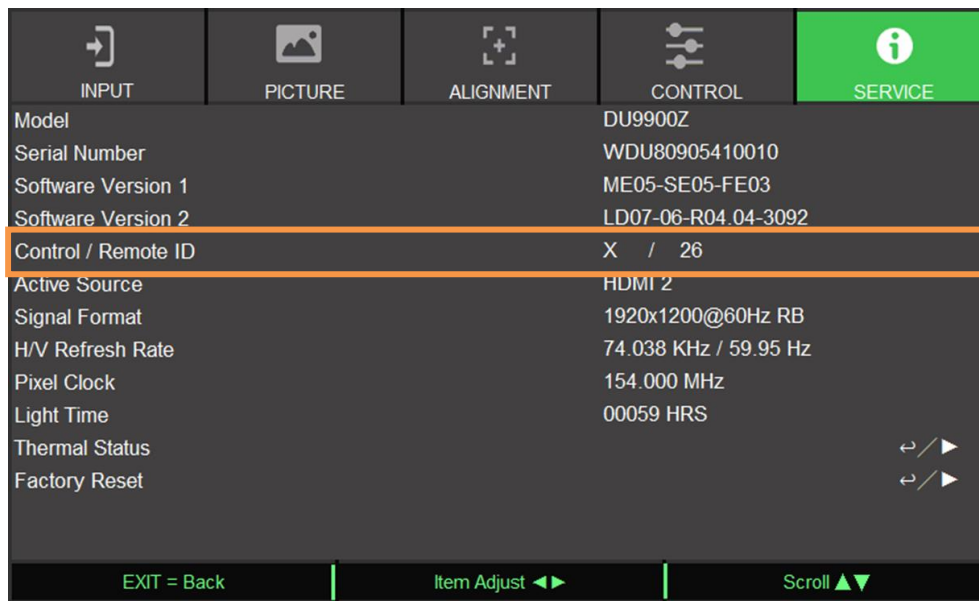

Note:

- Project ID Control function is available when the option is turned on and remote control wire is not plugged into the wire remote jack port.
- If ID Control Enable is set to Off, the projector can receive any control signal from the remote control. Even if the ID number is set into the remote control.

Using the Constant Brightness Function to Maintain the Brightness Output

The brightness output of a projector may decline after thousands of hours of usage. In certain applications, such as mapping, a periodical adjustment to multiple projectors is required to ensure the overall image result. Vivitek’s Constant Brightness feature is designed to reduce the need for installers to regularly recalibrate the projectors. A built-in light sensor inside the projector monitors the level of light so that when a reduction in light is detected, the projector will regulate dynamically the electricity power to increase the light output to your pre-defined brightness level, and thus maintaining a constant level of brightness. To use this function, follow the steps below:

1. Select SETUP > Light Power > Light Power. Change it to Custom Power Level with a value under 100%. For example: 90% or 85%. The reduced power percentage will be used to later regulate the brightness when the Constant Brightness function is enabled.

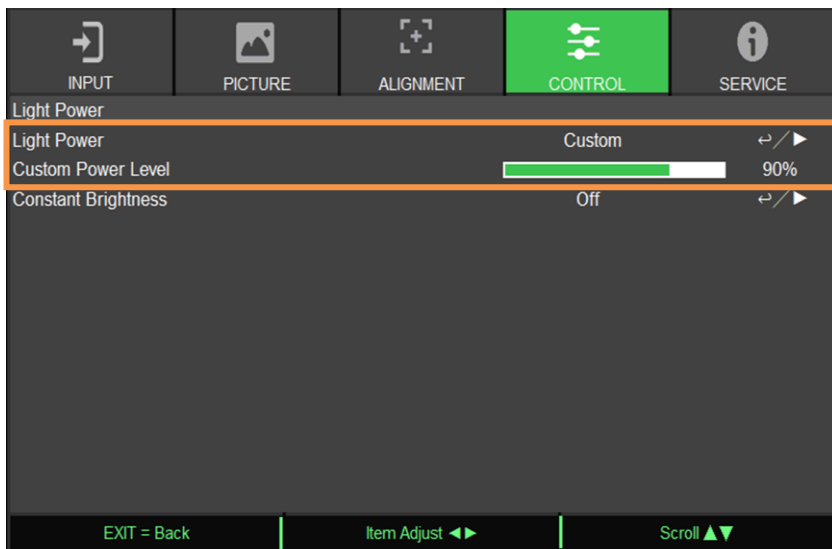

2. Enable the Constant Brightness function

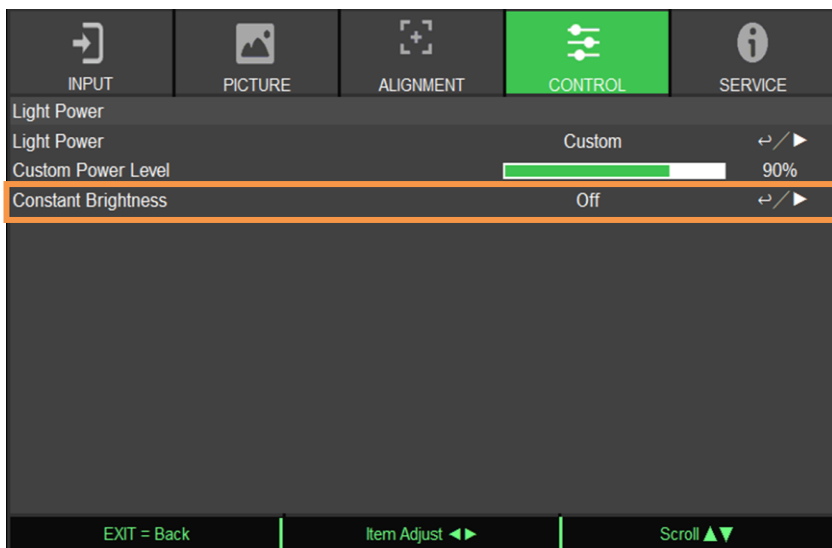

Note:

- After a long period of time, when a power boost reaches its limit of maximum power, the Constant Brightness function will no longer increase the electrical power to the laser light source. In this case, please turn off the Constant Brightness function. You can also readjust all the projectors to a new level of brightness with a lower Customer Power Level percentage, so that the Constant Brightness function will work again.

Connecting Equipment

Follow the instructions below to connect the DU9900Z projector to a video source or external control equipment (if any). When connecting to the equipment, use the correct signal cable to connect to the signal source and ensure that the cable is securely connected. Fasten the nut on the joint and connect the signal source equipment to the projector according to the image below.

Connecting a Computer

Connect the PC signal to be projected to the projector through the DVI-D, HDMI, DisplayPort, VGA or RGBHV (BNC) cable. If the signal to be input is a VGA signal, connect the VGA cable to the external display to simultaneously monitor the projected content.

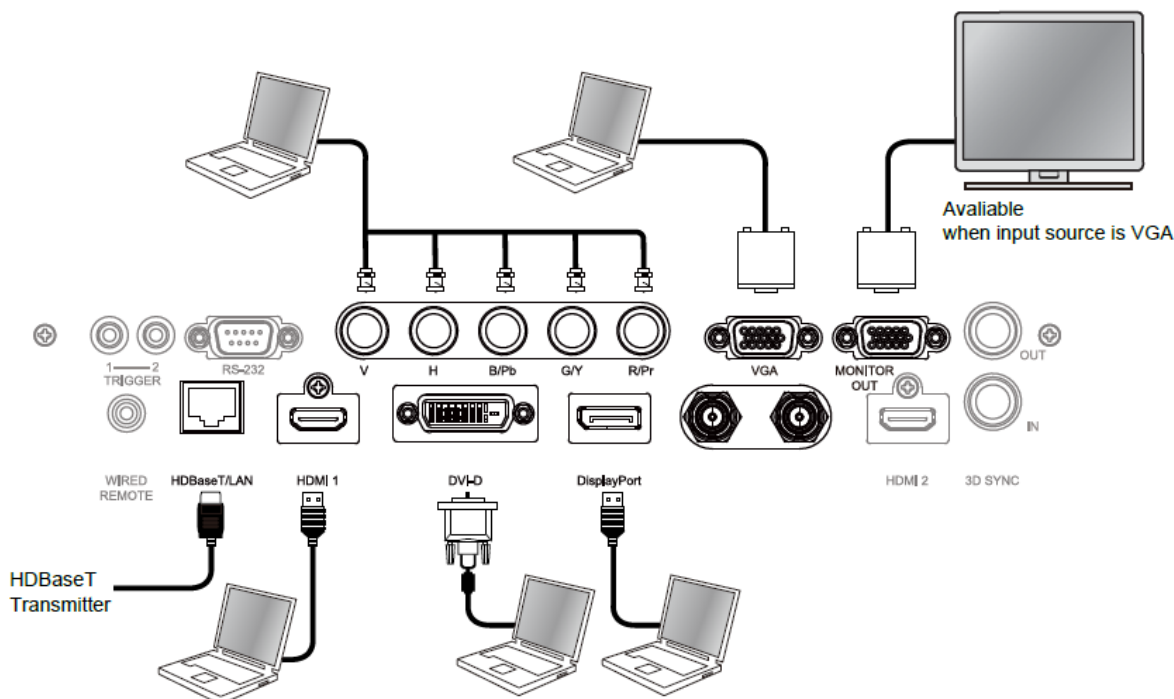

Connecting a Video Device

Connect video equipment to the input port of the projector via the DVI-D, HDMI and Component Video Connector.

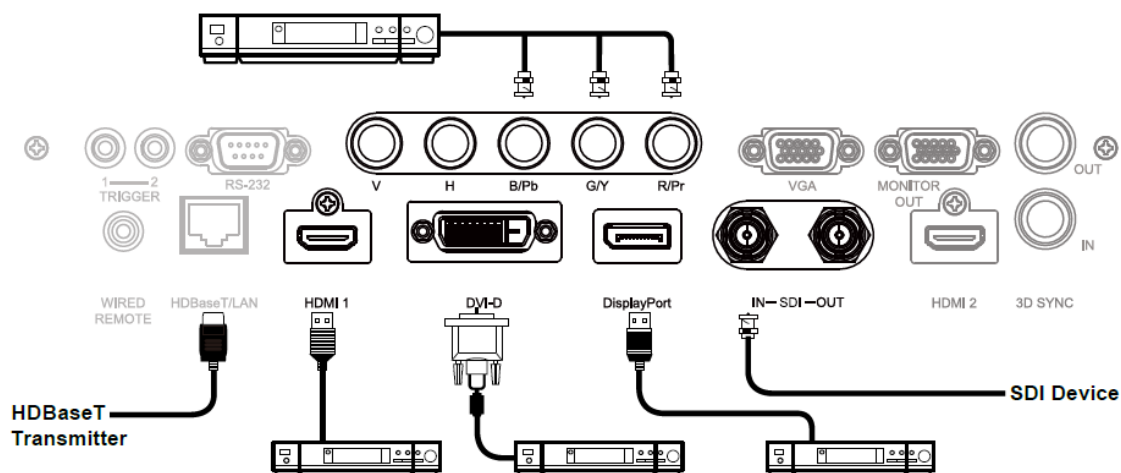

Connecting to a Control Equipment

The projector has the following control port for connecting to the control equipment:

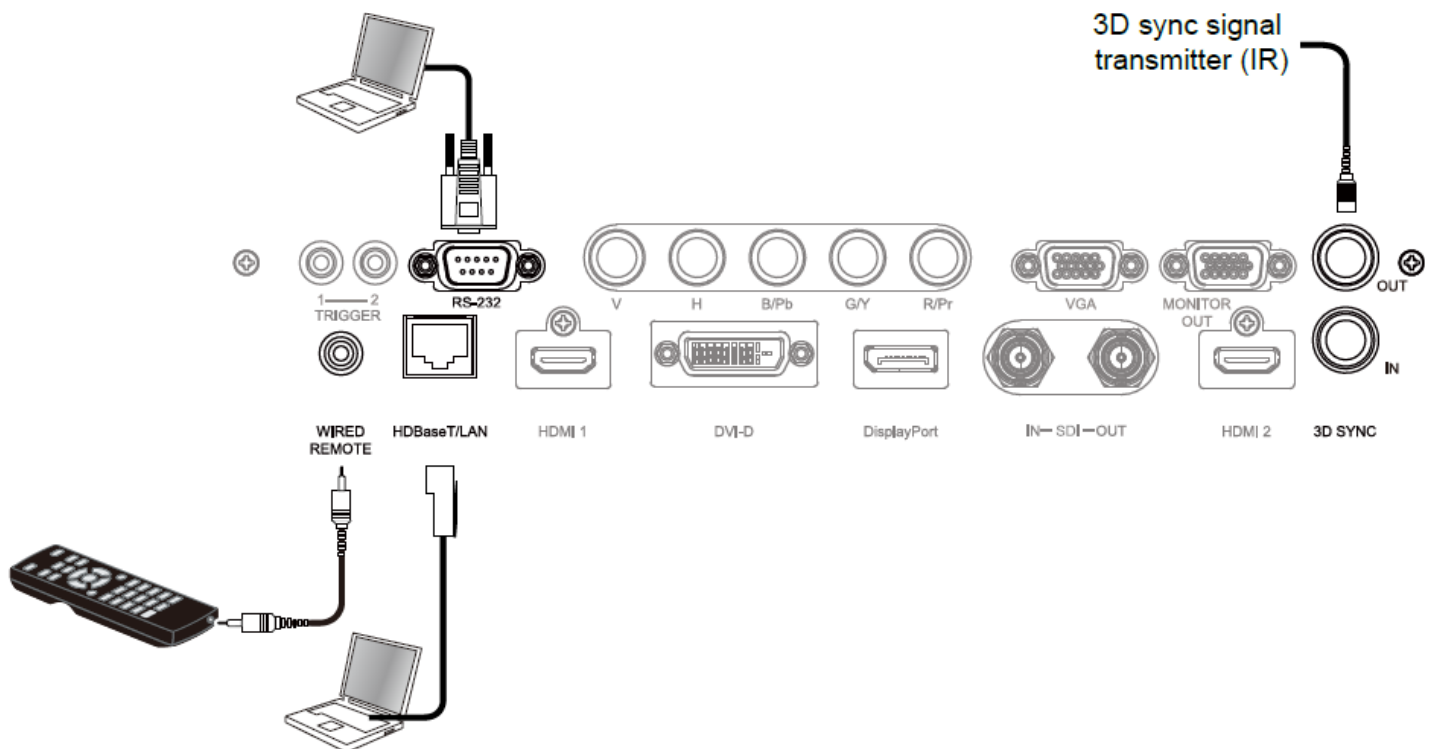

HDBaseT/LAN (Network control): The projector supports network control. LAN and HDBaseT share the same port. If only network control is used, you can connect the LAN on the projector to PC or through the local network. Refer to the Remote Communication Manual for detailed information.

RS-232 (RS-232 control): The projector can be remote-controlled by connecting the projector to a PC or control system through the standard 9-pin serial cable (Straight Through Serial Cable). Refer to the Remote Communication Manual for detailed information.

Wired remote control: If the projector cannot receive the IR signal from the remote control due to the overly long distance or obstacles, you can connect the cable to the IR remote control or the external IR transmitter (optional) via the WIRE input port to expand the working range of the remote control.

3D Sync Out/In: Connect to 3D IR sync signal transmitter or device.



Note:

- When the terminal of the remote control cable is inserted to the wired control terminal of the projector, the projector will automatically switch to the wired control mode and cannot be controlled through the IR signal of the remote control. Disconnect the wired control terminal on the projector if you want to control through the IR signal of the remote control.
- If the wired remote control cable or the external IR transmitter is inserted to the incorrect port such as Trigger, the remote control or the IR transmitter may be damaged. Make sure whether the port is correct.

Connecting a Screen Trigger

If your projection system includes a electric projection screen and other 12V trigger device, you can connect these devices to the projector's 12V trigger output port to configure the 12V signal settings. The projector will output 12V signals when it's turned on. You can use the signal to control the screen or device by turning on the OSD option under CONTROL -> Trigger 1 or Triger 2

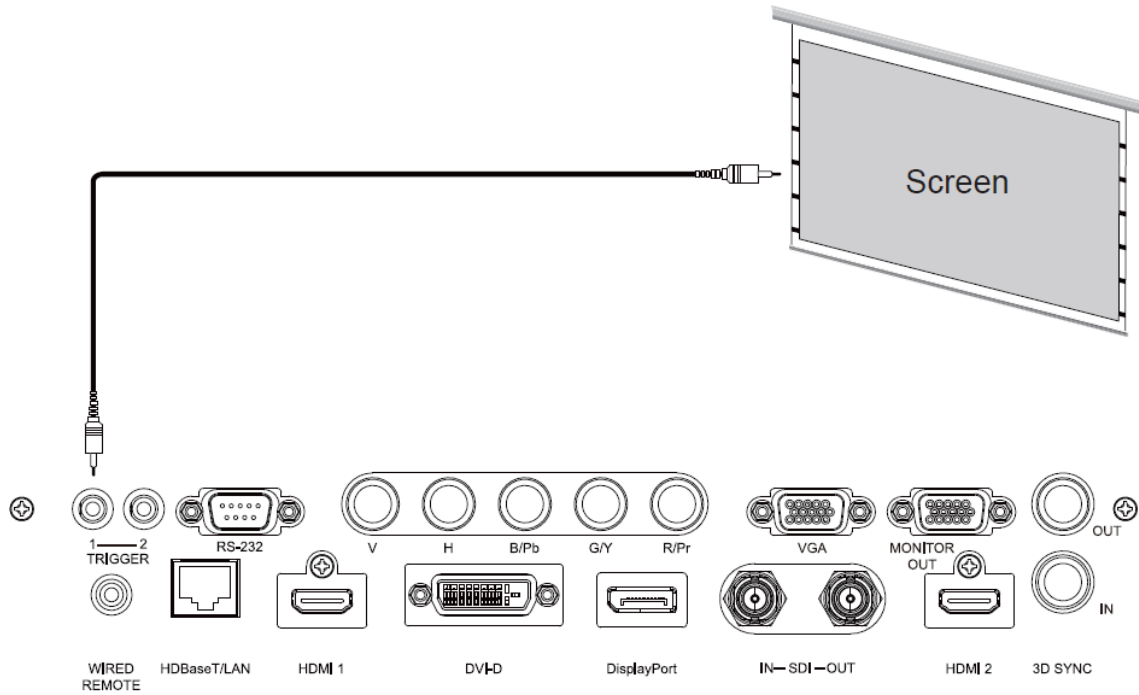

Connecting an HDBaseT Transmitter

The projector has a built-in HDBaseT receiver. With an HDBaseT Transmitter (optional), the video, RS-232 and LAN signals can be sent to the projector via a single RJ-45 cable. If the HDBaseT Transmitter you purchased supports the input and output of the IR remote control, the control signals from the IR remote control can be sent to the DU9900Z projector via the RJ-45 cable.

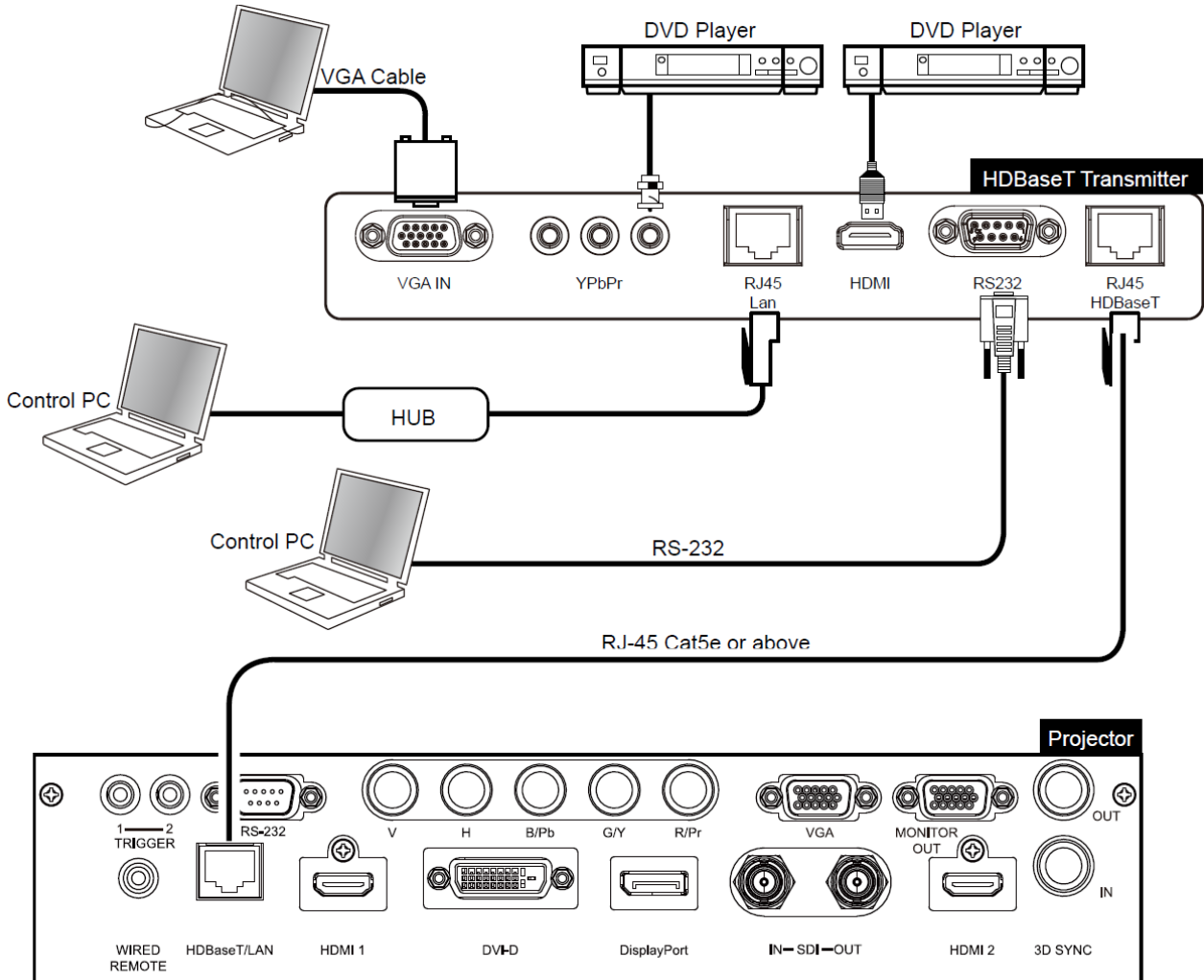

Note:

- The projector supports the video signal, R-232, IR remote control and the reception of the network control signals but do not support Power over Ethernet (PoE).
- The baud rate will be switched to 9600 automatically. If RS232 command is sent via external HDBaseT transmitter.
- If the command is sent via the HDBaseT transmitter, the longest transmission distance is 100 meters. If the transmission distance exceeds 100 meters, there is a possibility that the projection may be interrupted, or the control signal cannot be sent.
- Use the RJ-45 Cat5e or above cable and avoid entwining. Entwining may cause damage or signal transmission interference, thus reducing the transmission distance and degrading the image quality.

Using the Projector

Using On-Screen Display

Using the On-Screen Display

The projector has an On-Screen Display (OSD) that lets you make image adjustments, change various settings and check the projector's current status.

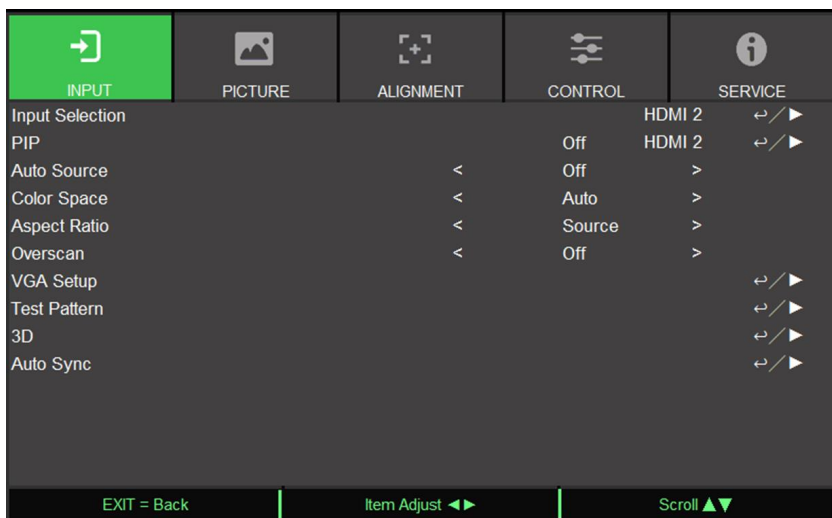

Navigating the OSD

You can use the remote control or the control buttons on the projector to navigate and make changes to the OSD. The following illustration shows the corresponding buttons on the remote control and on the projector.

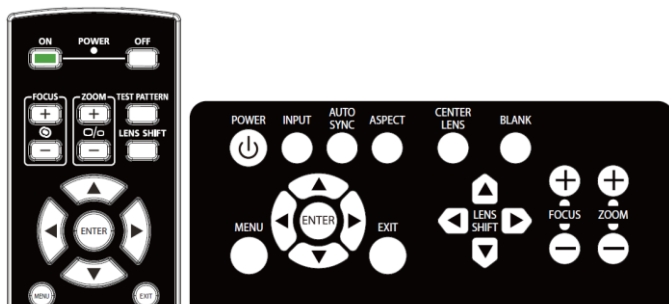

1. To open the OSD, press the Menu button on the OSD control panel or remote control. There are five folders on the menu. Press the ◀ or ▶ buttons to move through the submenus or secondary menus.

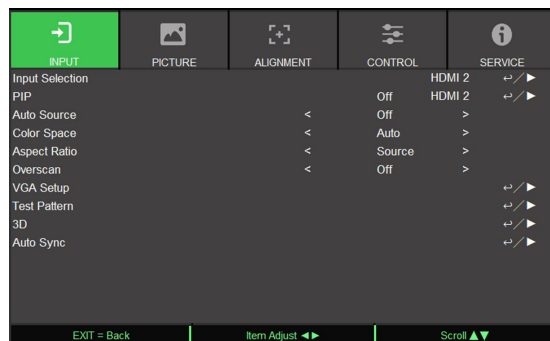

2. Press the ▲ or ▼ button to select the option and ◀ or ▶ button to change values for settings. Press ◀ to confirm the new setting.
3. Press **RETURN** to leave a submenu or MENU to close menu.

Menu Tree

Use the following table to quickly find a setting or determine the range for a setting.

INPUT

2nd Layer	3rd Layer	4th Layer	Selections
Input Selection			HDMI1 / HDMI2 / VGA / Component/BNC / DVI / DisplayPort / 3G-SDI / HDBaseT
PIP	PIP Option		Off / On
	PIP Input		HDMI1 / HDMI2 / VGA / Component/BNC / DVI / DisplayPort / 3G-SDI / HDBaseT
	Position		Top Left / Top Right / Bottom Left / Bottom Right / PBP
Auto Source			Off / On
Color Space			Auto / YPbPr / YCbCr / RGB-PC / RGB-Video
Aspect Ratio			5:4 / 4:3 / 16:10 / 16:9 / 1.88 / 2.35 / LetterBox / Source / Native
Overscan			Off / Crop / Zoom
VGA Setup	H Total		0~200
	H Start		0~200
	H Phase		0~200
	V Start		0~200
Test Pattern			Crosshatch / Color Bar / Checker Board / White / Red / Green / Blue/ Black
3D	3D Format		Off / Auto / Side by Side (Half) / Top and Bottom / Dual Channel / Frame Sequential
	Eye Swap		Normal / Reverse
	DLP Link		Off / On
	Dark Time		0.65ms/1.3ms/1.95ms
	Sync Delay		0~200
	Sync Reference		External / Internal
Auto Sync			Execute

PICTURE

2nd Layer	3rd Layer	4th Layer	Selections
Picture Mode			High Bright / Presentation / Video
Brightness			0~200
Contrast			0~200
Saturation			0~200
Hue			0~200
Sharpness			0~15
Noise Reduction			0~3
Color Temperature			5400K / 6500K / 7500K / 9300K / Native
Color Gamut			REC709 / EBU / SMPTE / Native
Gamma			1.0 / 1.8 / 2.0 / 2.2 / 2.35 / 2.5 / S-Curve / DICOM
Input Balance	Red Offset		0~200
	Green Offset		0~200
	Blue Offset		0~200
	Red Gain		0~200
	Green Gain		0~200
	Blue Gain		0~200

2nd Layer	3rd Layer	4th Layer	Selections
HSG	Red		
	Green		
	Blue	Hue	
	Cyan	Saturation	0~200
	Magenta	Gain	
	Yellow		
	White	Red Gain	
		Green Gain	0~200
		Blue Gain	
		Reset	
Dynamic Black			Off / On
Light Off Timer			Disable / 0.5 / 1.0 / 1.5 / 2.0 / 3.0 / 4.0 Seconds

ALIGNMENT

2nd Layer	3rd Layer	4th Layer	Selections
Lens Lock			Off / On
Lens control			Zoom / Focus / Shift control
Lens Memory	Load Memory		Memory1 / Memory2 / Memory3 / Memory4 / Memory5 /
	Save Memory		Memory6 / Memory7 / Memory8 / Memory9 / Memory10
	Clear Memory		
Center Lens			Execute
Lens Type			0.9 ~ 1.2 / 1.2 ~ 1.5 6 / 1.5 ~ 2.0 / 2.0 ~ 4.0 / 4.0 ~ 7.0
Digital Zoom	Digital Zoom		0% ~ 100%
	Digital Pan		0 ~ 100 (current input timing dependent)
	Digital Scan		0 ~ 100 (current input timing dependent)
	Reset		Execute
Warp	Keystone	Horizontal	-600 ~ 600
		Vertical	-400 ~ 400
		Rotation	-10 ~ 10
		Reset	Execute
	Rotation	Rotation	-100 ~ 100
		Reset	Execute
	Pincushion / Barrel	H Pin/Barrel	-150 ≤ H ≤ 300
		V Pin/Barrel	-150 ≤ V ≤ 300
		H keystone	-60 ~ 60
		V keystone	-40 ~ 40
	Arc	Rotation	-10 ~ 10
		Reset	Execute
		Top	- 150 ~ 150
		Bottom	- 150 ~ 150
	Top Left Corner	Left	- 150 ~ 150
		Right	- 150 ~ 150
Reset		Execute	
Horizontal		-192 <H<192	
Top Right Corner	Vertical	-120 <V<120	
	Reset	Execute	
	Horizontal	-192 <H<192	
	Vertical	-120 <V<120	
	Reset	Execute	

2nd Layer	3rd Layer	4th Layer	Selections	
Warp	Bottom Left Corner	Horizontal	-192 <H<192	
		Vertical	-120 <V<120	
		Reset	Execute	
	Bottom Right Corner	Horizontal	-192 <H<192	
		Vertical	-120 <V<120	
		Reset	Execute	
		Custom Warp		Off / User 1 / User 2
	Blanking	Top		0 ~ 360
		Bottom		0 ~ 360
Left			0 ~ 534	
Right			0 ~ 534	
Reset			Execute	
Custom Masking			Off / User 1 / User 2	
Warp Filter	Auto			
	Manual	H Warp Filter	1 ~ 10	
		V Warp Filter	1 ~ 10	
Edge Blend	Edge Blend		Off / On	
	Align Pattern		Off / On	
	Blend Start	Top		0 ~ 390
		Bottom		0 ~ 390
		Left		0 ~ 710
		Right		0 ~ 710
	White Level	Top		0, 100 ~ 500
		Bottom		0, 100 ~ 500
		Left		0, 100 ~ 800
		Right		0, 100 ~ 800
	Black Level	Top		0 ~ 32
		Bottom		0 ~ 32
		Left		0 ~ 32
		Right		0 ~ 32
		All		
Red			0 ~ 255	
Green			0 ~ 255	
Blue		0 ~ 255		
	Reset		Execute	
Screen Setting	Screen Format		16:10 / 16:9 / 4:3 / 2.35:1	
	Screen Position		Gray out (Screen Format 16:10) -16 ~ 16 (Screen Format 16:9) -160 ~ 160 (Screen Format 4:3) -191 ~ 191 (Screen Format 2.35:1)	

CONTROL

2nd Layer	3rd Layer	4th Layer	Selections
Lanauage			English / Français / Español / Deutsch / Português / 简体中文 / 繁體中文 / 日本語 / 한국어
Projection Mode			Front Desktop / Front Ceiling / Rear Desktop / Rear Ceiling / Auto-front
High Altitude			On / Auto
Auto Power Off			Off / On
Auto Power On			Off / On
Network	Network Mode		Projector control / Service
	Standby Power		Off / On

2nd Layer	3rd Layer	4th Layer	Selections
	Network Setup	DHCP	Off / On
		IP Address	xxx.xxx.xxx.xxx
		Subnet Mask	xxx.xxx.xxx.xxx
		Gateway	xxx.xxx.xxx.xxx
		DNS	xxx.xxx.xxx.xxx
		MAC Address	xx:xx:xx:xx:xx:xx
		Apply	(OK) to Execute
		Art-Net Enable	Off / On (2.X.X.X) / On (10.X.X.X) / On (Manual)
		Net	0 ~ 127
		Sub Net	0 ~ 15
	Art-Net Setup	Universe	0 ~ 15
		Start Address	1 ~ 508
		Apply	(OK) to Execute
		Channel 1	
	Art-Net Channel Setting	Channel 2	
		Channel 3	None / Power / PIC-MUTE / Power Level / Input / Channel Control
		Channel 4	
		Channel 5	
		Channel 1	
	Art-Net Channel Status	Channel 2	None / Power / PIC-MUTE / Power Level / Input / Channel Control
		Channel 3	
		Channel 4	
		Channel 5	
		Channel 5	
Light Power	Light Power		Eco / Normal / Custom
	Custom Power Level		20~100
	Constat Brightness (CBC)		Off / On
Background			Logo / Black / Blue
Startup Logo			Off / On
Infrared Remote	Remote Sensor		Off / On
	ID Control Enable		Off / On
	Control ID Number		1 ~ 99
Trigger-1			Off / Screen / 5:4 / 4:3 / 16:10 / 16:9 / 1.88 / 2.35 / LetterBox / Source / Native
Trigger-2			Off / Screen / 5:4 / 4:3 / 16:10 / 16:9 / 1.88 / 2.35 / LetterBox / Source / Native
OSD Settings	Menu Position		Top-Left / Top-Right / Bottom-Left / Bottom-Right / Center
	Menu Transparency		0 / 25 / 50 / 75
	Time Out		Always On / 10 Seconds / 30 Seconds / 60 Seconds
	Message Box		Off / On
	Control Panel lock		Off / On
	Security Lock		Off / On
Image Latency			Normal / Fast

SERVICE

2nd Layer	3rd Layer	4th Layer	Selections
Model			
Serial Number			
Software Version 1			
Software Version 2			
Control / Remote ID			
Active Source			
Signal Format			
H/V Refresh Rate			
Pixel Clock			
Light Time			
System Status	Atmospheric Pressure		
	AC Voltage		
	Ceiling Mode		
	Tilt Mode		
	Portrait Mode		
	Altitude Mode		
	Laser Power		
	Constant Brightness		
	Color Sensor Status		
	LSR DRV Status		
Thermal Status	Intake Temp		
	DMD Temp		
	LD Temp		
	Fan 1-4 Speed		
	Fan 5-8 Speed		
	Fan 9-12 Speed		
	Fan13-16 Speed		
	Fan 17-20 Speed		
	Fan 21-24 Speed		
Water Pump RPM			
Factory Reset			Execute

OSD Menu – INPUT

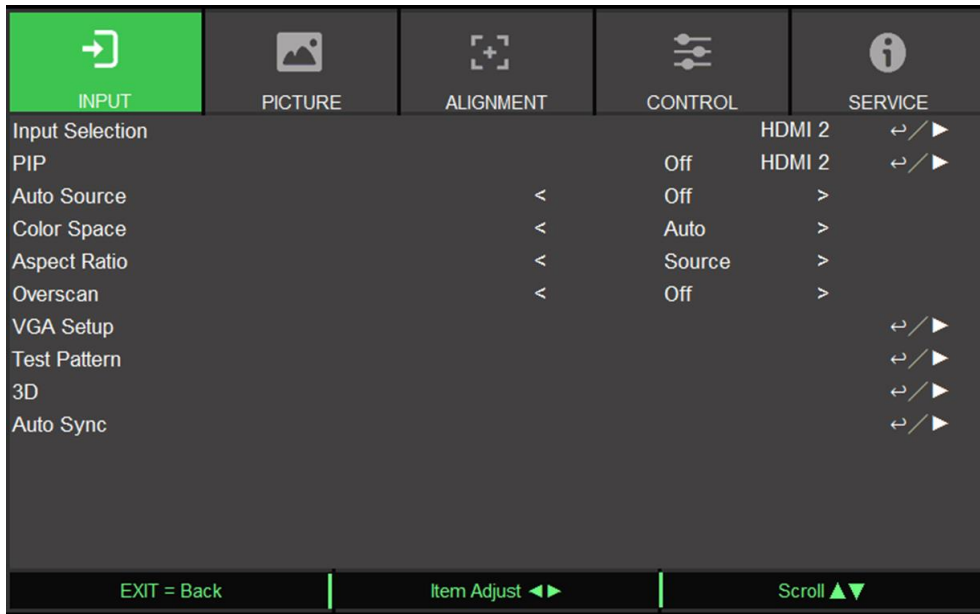

Input Selection

Use the shortcut key on the remote control or this function to select the input source. The Input options are as below. The available input source of the product is HDMI 1, HDMI 2, DisplayPort, VGA, Component (BNC), HDBaseT, DVI-D and 3G-SDI.

PIP

This function allows you to split the screen for displaying the images from two input sources.

PIP Option

Enable PIP by choosing “ON”, and two windows will be shown on the projected picture. The larger one is the primary picture, the smaller one is the sub picture. By choosing “Off”, PIP function will be disabled, and only one picture window will be projected.

PIP Input

Press ENTER to display available sources for the sub picture, and then select a source.

Note: The unavailable input sources of sub-menu will be grayed out and cannot be selected. The available input source of the sub picture is outline in the below chart.

		Main Picture							
		VGA	Component	HDMI 1	HDMI 2	DisplayPort	HDBaseT	3G-SDI	DVI-D
Sub Picture	VGA			○		○*	○		○
	Component			○		○*	○		○
	HDMI 1	○	○		○			○	
	HDMI 2			○		○*	○		○
	DisplayPort	○*	○*		○*			○*	
	HDBaseT	○	○		○			○	
	3G-SDI			○		○*	○		○
	DVI	○	○		○			○	

O*: Pixel rate should be less than 165MHz

Position

Find preferred location of PIP window.

Top Left: Display sub picture at top left of the screen.

Bottom Left: Display sub picture at bottom left of the screen.

Top Right: Display sub picture at top right of the screen.

Bottom Right: Display sub picture at bottom right of the screen.

PBP: Display sub picture next to main picture, the main screen is shrined to the same size as sub picture.

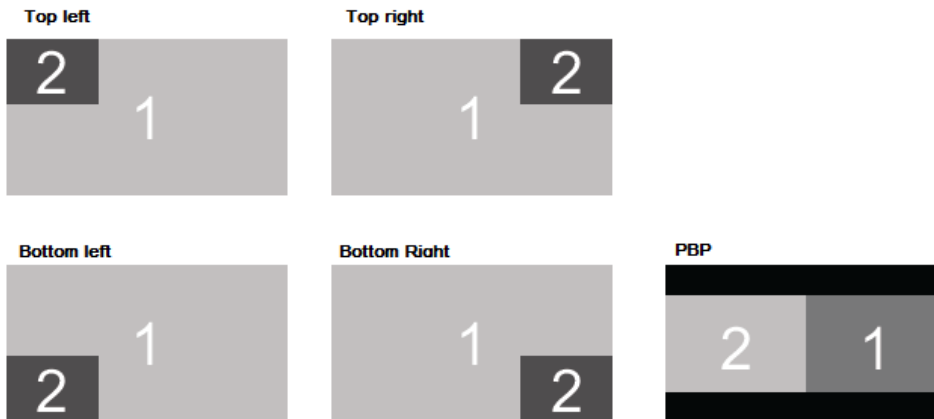

Auto Source

The Auto Source functions "ON" lets projector automatically search for the input signal.

Color Space

This function allows you to change the corresponding color space for the input signal in most cases, the default is Auto.

Auto: The projector detects the input signal and switches to the corresponding color space automatically.

YPbPr: Set the color space to ITU-R BT 601.

YCbCr: Set the color space to ITU-R BT 709.

RGB-PC: Use the RGB color space and set the black to 0, 0, 0 RGB, while set the white to 255, 255, 255 RGB (if an 8-bit image is used).

RGB-Video: Use the RGB color space and set the black to 16, 16, 16 RGB while set the white to 235, 235, 235 (if an 8-bit image is used) to correspond to the luminance value defined in the digital component standard.

Aspect Ratio

This function allows the user to adjust the aspect ratio of the projection image by the ◀ or ▶ button.

Overscan

Noise may appear on the edge of the projected image or image may be smaller than projected image, select below option to hide the noise or extend the image.

Off: Display the original image.

Crop: Hide the edge of the image

Zoom: Extend the image to fit the projected area as possible.

VGA Setup

Set the H Total, H Start, H Phase and V Start for the VGA signal by ENTER key.

Test Pattern

The built-in images are provided for installation and adjustment. You can select TEST PATTERN or Test Pattern on OSD or the TEST PATTERN button on the remote control to show the test pattern. Press the ◀ or ▶ button to select pattern or press EXIT key again to exit the test pattern. The available test pattern options are Crosshatch, Color Bar, Chess Board, White, Red, Green, Blue and Black.

3D

This function is to set the 3D format and sync method. The projector detects the type of input signals and provides relevant options for settings. Before performing 3D setting, make sure that the input signal is connected.

3D Format

Off: Turn off the 3D Display Mode. When Auto, Side by Side, Top and Bottom, or Frame Sequential is selected, the 3D Mode will be turned on. To turn off the 3D Mode, select "Off" and press "ENTER".

Auto: Allow the 3D format to automatically detect the formats of Frame Packing, Top and Bottom, and Side by Side. The input signal is HDMI 1.4b 3D.

Side by Side (Half): This option is only applicable to input signal HDMI 1.4b 3D or HDMI signal sent by HDBaseT Transmitter.

Top and Bottom: This option is only applicable to input signal HDMI 1.4b 3D or HDMI signal sent by HDBaseT Transmitter.

Frame Sequential: Set input format under Frame Sequential.

Eye Swap: If the 3D image transmitted to the 3D glasses is reverse, you can set the Eye Swap to "Reverse" to normalize the image. Otherwise, keeping mode of "Normal" would be suggested.

DLP Link: This function is to activate or deactivate the DLP Link sync.

Dark Time: Manually switch the Dark time for glasses tolerance, the available options are 0.65ms, 1.3ms and 1.95ms.

Sync Delay: If the 3D display shutter switch time of different brand 3D product is not synchronized with the projector, it will cause ghosting or poor 3D effect. Please adjust the sync delay to synchronize the 3D machine shutter and the projector shutter switching time for the best 3D projection.

Sync Reference: The projector provides DLP Link and 3D IR sync for 3D display, the projector will automatically set the sync signal depended on the 3D format and if the external 3D sync device is connected. This function is only applied to the condition that 3D Format is Frame Sequential or external 3D sync device is connected to the projector.

External: Signal is sent from external 3D sync signal receiver.

Internal: Signal is sent by the projector, 3D sync signal is DLP Link.



Important reminders:

- People with the following conditions should view 3D image with great care:
 - Children under six years in age
 - People who are sensitive to light or allergic to light, unhealthy and have a history of cardiovascular diseases.
 - People who are tired or lack of sleep
 - People who are under the impact of drugs or alcohol
 - Normally, it is safe to watch 3D images. However, some people might feel uncomfortable. Refer to the guidelines that were revised and released by the 3D League on December 10, 2008. It states that those who watch 3D images, need to take a break for at least 5 to 15 minutes every thirty minutes or one hour.

Auto Sync

You can use this function to execute signal source auto synchronization.

OSD Menu – PICTURE

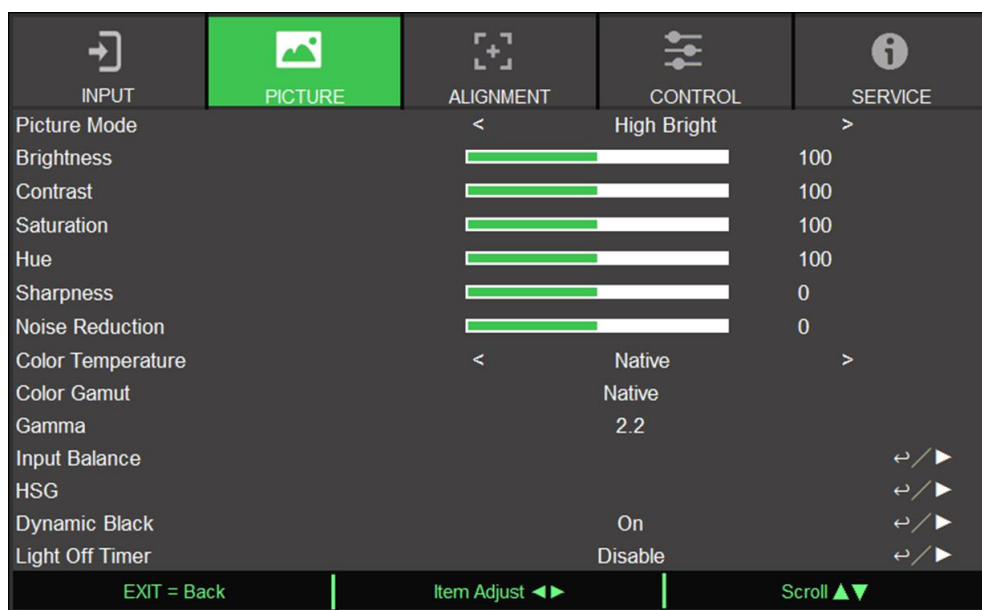

Picture Mode

Use ◀ or ▶ to select desired picture mode

High Bright: The highest brightness output mode is suitable for the application where the highest brightness output is needed.

Presentation: The best projection effect is suitable for the presentation or picture.

Video: The mode is suitable for playing video content.

Brightness

Press ENTER, and use the ◀ or ▶ button to increase or decrease the level of brightness.

Contrast

Press ENTER, and use the ◀ or ▶ button to adjust the contrast of the projected image.

Saturation

Press ENTER, and use the ◀ or ▶ button to adjust the level of saturation.

Hue

Press ENTER, and use the ◀ or ▶ button to adjust the level of hue.

Sharpness

Press ENTER, and use the ◀ or ▶ button to adjust the sharpness, which changes the high-frequency details.

Noise Reduction

Use ◀▶ to adjust the noise of the projected image. This function is used to remove the noise of the image with interlaced scanning input. Generally, noise reduction can lower the high-frequency details and make the image softer.

Color Temperature

The default of color temperature is Native, and it is suitable for most situations. As color temperature rises, the picture will appear bluer, while as the color temperature decreases, the picture will appear redder. The available options are Native, 5400K, 6500K, 7500K and 9300K

Color Gamut

This function allows you to set the color display range according to application; the available options are REC709, EBU SMPTE and Native.

Gamma

When the ambient light is so bright that may affect the projection of the details in the dim area of the image, you can change the gamma to adjust the chrominance. The available options are 1.0, 1.8, 2.0, 2.2, 2.35, 2.5, S-Curve and DICOM.



Note for DICOM:

- The DICOM option under this function can be used to enhance the gray scale level for viewing grayscale medical images, such as X-rays for training and educational purposes only.
- The projector is not a medical device and cannot be used for medical diagnosis.

Input Balance

When ambient light is too bright or changes, the projected image details may be affected, you can adjust the option to make the projected colors of image closer to desired colors. There are two options for fine tuning Red, Green and Blue

Offset: These three options will shift the color spectrum for the whole image and change its brightness, if minimal amount of red, green or blue appears in the gray areas, you can adjust the offset of the corresponding color accordingly. By increasing the offset, the image brightness will become lower.

Gain: These three options are used to increase or decrease the range of color input for the entire image. If minimal amount of red, green or blue appears in the gray areas, lower the gain of the corresponding color accordingly. As gain increases, the contrast of the image will become lower.

HSG

HSG is a function to adjust Hue, Saturation and Gain independently, it allows for specified color adjustments that are more intuitive. You can adjust Hue, Saturation and Gain for Red, Green, Blue, Cyan, Magenta, Yellow and white independently.

Dynamic Black

This function can be used to enhance the black levels of the projected image dynamically per the content of the input signal if it's set to On.

Light Off Timer

If the content contains full black frames, you can enable this function and select the preferred timer to switch the light source Off-to-On dynamically. This can be used to eliminate the bright blocks of overlapping area in multi-projectors application. For example, the projection light is switched off dynamically if the timer is set to 0.5 seconds and the content contains full black frames over 0.5 seconds.

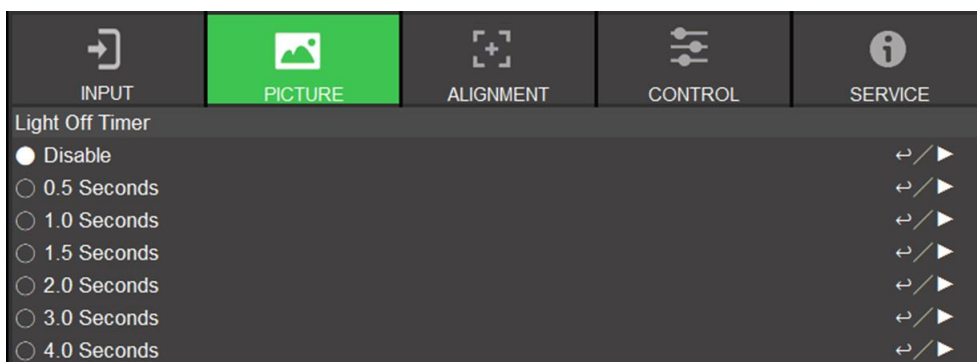

Note:

- Light Off Timer is available when Dynamic Black function is turned on.

OSD Menu – ALIGNMENT

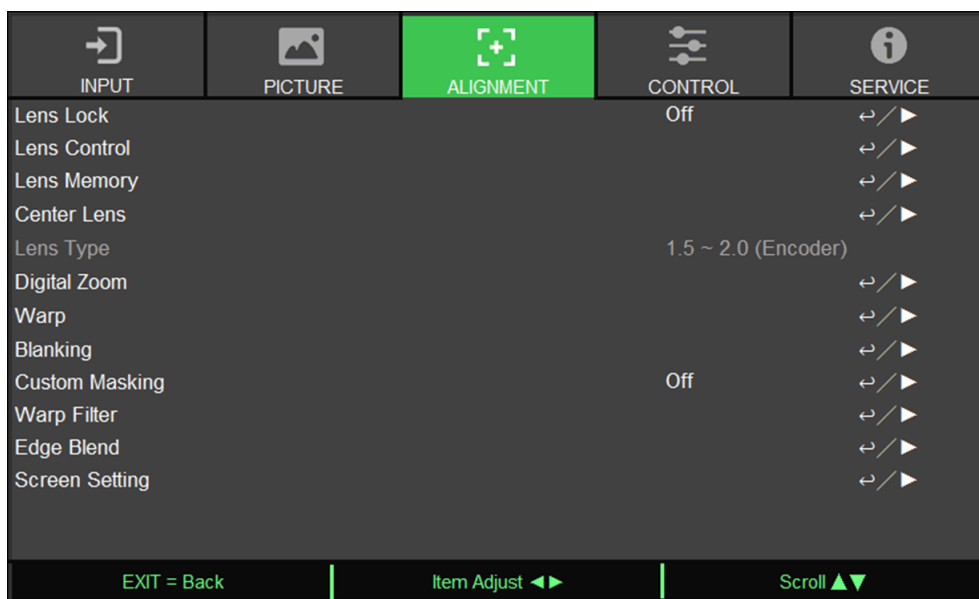

Lens Lock

This function can be used to disable lens control for preventing unauthorized operation or disoperation in lens control related functions and includes: Lens Shift, Zoom/Focus adjustment and Center Lens. It is recommend to turn on Lens Lock function to disable the Lens control after lens adjustment is done.



Important:

- Turning on Lens Lock will disable lens control function including Lens Shift, Center Lens and Zoom/Focus adjustment. Please make sure Lens Lock is disabled before you perform the lens control function.

Lens Control

Select this function to open Lens Control menu for adjustment of Zoom, Focus, or Shift. You can use the ENTER button to switch the Zoom / Focus or Shift menu. Use the ▲ or ▼ button to adjust zoom and vertical shift of the lens, or use the ◀ or ▶ button to adjust focus and horizontal shift of the lens.

Lens Memory

This projector supports Lens Memory function, Lens shift, Zoom and Focus memory can be stored in the projector up to 10 sets. You can load the stored memory setting to set up the lens automatically.

Select Lens memory 1~10 :

ENTER key to Save/Load. Press ▶ to switch Load/Reset state. CLEAR key to Reset.

Center Lens

This is the lens calibration function; the projector calibrates the lens shift for the precise lens memory function. After performing this function, the lens will be moved to the center position as factory default setting.

Lens Type

This projector can be used with 5 different projection lenses. The projector preset five initial projection positions for these types accordingly, Center Lens function can moves the lens to the initial position (center) automatically per the setting.

Digital Zoom

Press ENTER button to enlarge the image or move the image.

Digital Zoom: Use the ▲ or ▼ button to enlarge the projected image.

Digital Pan: Use the ▲ or ▼ button to move the projected image horizontally. This function is only available when projected image is enlarged.

Digital Scan: Use the ▲ or ▼ button to move the projected image vertically. This function is only available when projected image is enlarged.

Reset: The setting will be reset to default value.

Warp

This function is used to correct the distortion of image.

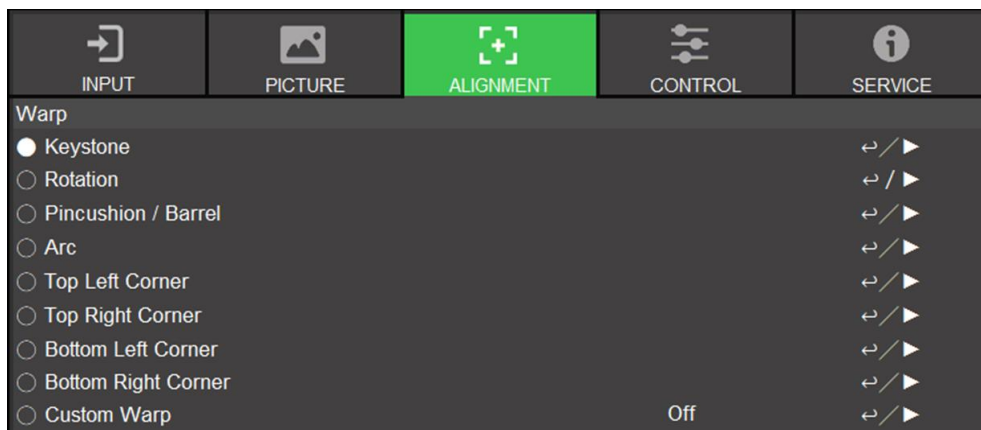

Keystone: Press the ▲ or ▼ button to correct horizontal distortion or the ▲▼ button to correct vertical distortion.

Rotation: Press the ▲ or ▼ button to correct incorrect angle of image.

Pincushion / Barrel: Press the ▲ or ▼ button to correct pincushion/barrel distortion.

Top Left Corner: Press the ▲ or ▼ button to correct the distortion at top-left of the picture.

Top Right Corner: Press the ▲ or ▼ button to correct the distortion at top-right of the picture.

Bottom Left Corner: Press the ▲ or ▼ button to correct the distortion at bottom-left of the picture.

Bottom Right Corner: Press the ◀ or ▶ button to correct the distortion at bottom-right of the picture.

Custom Warp: Apply the geometry adjustment by using vivitek PJ Control (Pro) tool.

Blanking: This function can adjust the edges of the image and hide surplus sections of the projection.

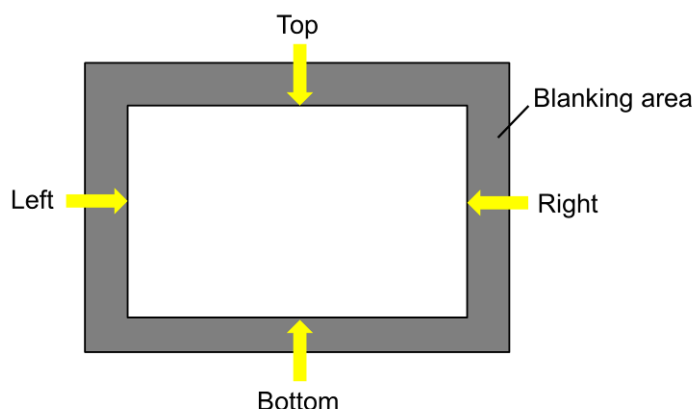

Top: Press the the ▲ or ▼ button to adjust the top blanking area on the projected picture.

Bottom: Press the the ▲ or ▼ button to adjust the bottom blanking area on the projected picture.

Left: Press the ◀ or ▶ button to adjust the left blanking area on the projected picture.

Right: Press the ◀ or ▶ button to adjust the right blanking area on the projected picture.

Reset: All the settings toward blanking will set to default.

Custom Masking: Apply the masking area drawn by using vivitek PJ Control (Pro) tool.

Warp Filter: Select manual or auto method to specify the horizontal/vertical interpolation LUT (Lookup Table) applied for regular geometry.

Edge Blend

Edge Blend function requires multiple projectors to simultaneously project on the same screen. Use this function to adjust the uniformity of image. To use this function, Edge Blend must be enabled on both projectors.

Edge Blend: Select On to enable this function. Following functions are available when this option is turned on; otherwise, the functions are grayed out.

Align Pattern: This function can be used to display the auxiliary lines for displaying the overlapping area; the line is moved with the value of white level you set.

Blend Start: Set the start position of overlapped area for blending.

White Level: White Level is used to set the overlapped area for blending in multi-projection application, the overlapping When projecting White, the area where the two images overlap is projected twice the projectors' white output levels. The solution is to adjust the White Level. First make sure that the units connected to the projectors are outputting black. Then increase the White Level (Top, Bottom, Left, and Right) until the non-overlap area's brightness matches the overlap area.

Black Level: The purpose of Black Level is to increase the black level of non-overlapping area. When projecting black, the area where the two images overlap projects twice the projectors' black output levels. The solution is to adjust the Black Level. First make sure that the units connected to the projectors are outputting black. Then increase the Black Level (Top, Bottom, Left, and Right) until the non-overlap area's brightness matches the overlap area.

Reset: All the settings toward edge blend will set to default.

Screen Setting: Set screen size and position.

Screen Format: Sleet the screen format to 16:10, 16:9, 4:3 and 2.35:1.

Screen Position: Adjust the position of screen.

OSD Menu – CONTROL



Language

Select OSD language and choose from one of the 8 available languages options. Available languages include: English, Français, Español, Deutsch, Português, 简体中文, 繁體中文, 日本語, 한국어.

Projection Mode

Use the ◀ or ▶ buttons to select a projection mode to change the direction of the image. The selectable options are as follows:

Auto-Front: One orientation sensor is built in the projector. In front projection installation, you can select this option to flip the projected image automatically.

Front Desktop: Install the projector on the desktop and project the image forward.

Rear Desktop: Install the projector on the desktop and project the image from the rear of the screen.

Front Ceiling: Mount the projector on the ceiling and project the image forward.

Rear Ceiling: Mount the projector on the ceiling and project the image from the rear of the screen.

High Altitude

Use this function to adjust the cooling fan of the projector to get well cooling if the projector is installed in an area over 4000 feet. The projector is equipped with an altitude sensor which is capable of detecting atmosphere pressure for estimating altitude. If the Auto option is set to "AUTO", then the system can adjust automatically to corresponding settings that are based on an estimated altitude. If you prefer to manually set this feature, you can select On or Off.

Off: Turn off High Altitude mode if the projector is installed in an area under 4000 feet.

On: Turn on High Altitude mode if the projector is installed in an area over 4000 feet.

Auto: Set up this mode automatically by estimated altitude.



Important:

- Improper setting may cause to insufficient air flow for system cooling, then trigger system protection, please make sure the setting can match with the installation condition.
- Estimate Altitude is calculated by the atmospheric pressure. There is a tolerance when comparing to actual altitude. If any over temperature or system protection message appears, please manually adjust the High Altitude settings to On
- In some applications, regular cooling fan settings may not supply enough cold air for system cooling even when the projector is installed in an area under 4000 feet. In this case, please switch the High Altitude to On.

Auto Power Off

This function is set to OFF by default. When it is set to ON and no input signal is received within 20 minutes, the projector will turn off automatically.

Auto Power On

This function is set to OFF by default. When it is set to ON, the projector will turn on automatically when the AC power is turned on the next time. You can use this function and the power switch (instead of the remote control) to turn on the projector. Set this function to OFF if it's unnecessary.

Network

Use this function to configure the network settings, so that you can control the projector via the network. Press the ▲ or ▼ button and Enter button to select Network and network settings. Please refer to Remote Communication Manual for further information.

"Art-Net" is an Ethernet communication protocol based on the TCP/IP protocol. Art-Net is made based on DMX512 communication protocol. Illumination and stage system can control projector by using the DMX controller and the application software.

Network Mode

Projector control : Display the IP address of projector. You can input the correct IP address to control the projector via the internet.

Service : If you want to upgrade the software of projector. Use this function to query the Service's ip address. Then enter the correct Service IP address to upgrade the projector's software via the internet.

Standby Power

This option allows you to set up power consumption at standby status,

On: Projector maintains in the standby at higher power consumption (< 6W) for projector control via LAN. In this mode, the projector can be turned on by RS-232 command or web control.

Off: Projector maintains in the standby at lowest power consumption (<0.5W), the projector can be turned on by the power button on the remote control or control panel only.

Network Setup

DHCP: Set DHCP to ON/OFF. When DHCP is set to ON, the DHCP server of the domain will assign an IP address to the projector. The IP address will appear on the IP address window without need to make any input. If the domain cannot assign any IP address, 0.0.0.0 will be shown on the IP address window.

IP Address: To specify an IP address, press the Enter button to show the IP address input window. Use the ◀ or ▶ button to select the number in the address to change. Use the ▲ or ▼ button to increase or decrease the number in the IP address. Network IP Address 172. xxx. xxx. xxx.

Subnet Mask: Set the subnet mask. The input method is the same as the setting for IP address.

Gateway: Set the gateway. The input method is the same as the setting for IP address.

DNS: Set the DNS. The input method is the same as the setting for IP address.

MAC Address: Shows the projector's MAC Address.

Apply: Apply the settings.

Art-Net Setup: Setup the settings of Art-Net.

Art-Net Enable :

Off : Disable Art-Net.

On(2.x.x.x) and On (10.x.x.x) : IP will be calculated automatically.

ON(Manual) : Setting IP address manually.

Net : 0~127(Select Net groups)

Sub Net: 0~15 (Select Sub-Net for each Net)

Universe : 0~15 (Select universes for each Sub net.)

Art-Net Channel Setting: Set function mapping for each channel of Art-Net. The Channel Setting definition is used to control projector with Art-Net. Please refer below table :

Art-Net Channel Status: Shows current channel function mapping of Art-Net.

Art-Net Channel Control Details					
Channel	Channel Function	Performance	Channel Parameter	Default Value	Operation Content
1	Power	Standby	0 ~ 63	128	Light on/off projector
		No Operation	64 ~ 191		
		Power On	192 ~ 255		
2	PIC-MUTE	Shutter Open	0 ~ 63	128	Enable / Disable AV Mute
		No Operation	64 ~ 191		
		Shutter Closed	192 ~ 255		
3	Power Level	30%	0 ~ 115	255	Adjust brightness level of projector
		31%	116 ~ 117		
			
		99%	252 ~ 253		
		100%	254 ~ 255		
4	Input	No Operation	0 ~ 31	0	Change input source
		HDMI 1	32 ~ 47		
		HDMI 2	48 ~ 63		
		VGA	64 ~ 79		
		BNC (Component)	80 ~ 95		
		DisplayPort	96 ~ 111		
		No Operation	112 ~ 127		
		HDBaseT	128 ~ 143		
		3G-SDI	144 ~ 159		
		DVI	160 ~ 175		
		No Operation	176 ~ 255		
		5	Channel Control(*)		
No Operation	64 ~ 191				
Channel control is enabled	192 ~ 255				

(*): Not accepted for all other channels operation when set to 'Disable'.

Light Power

There are three options under Light Power for adjusting or fine turning the light power to set the desired brightness output.

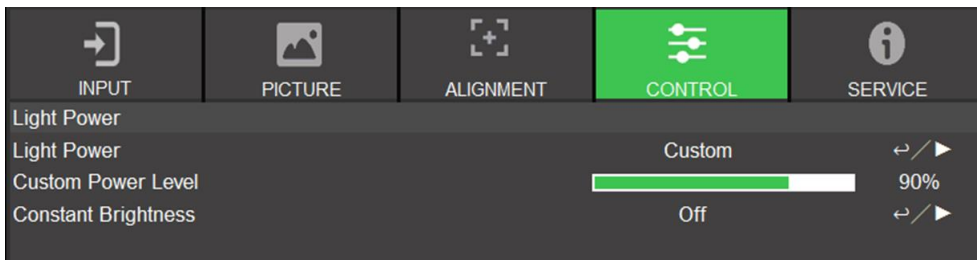

Light Power: Use the ◀ or ▶ buttons to select the Eco, Normal or Custom Power Level mode.

Eco: Projector operates in the energy-saving mode, which is equivalent to 80 % power of light source.

Normal: Projector operating with normal light power can obtain the brightest projection display.

Custom Power Level: User can enable the custom power level mode.

Custom Power Level: Select this function and use the ◀ or ▶ buttons to adjust light power to between 100% and 20%.

Note: this function is enabled only when Laser Mode is set to the Custom Power Level.

Constant Brightness: Select On to enable this function. A built-in light sensor inside the projector monitors the level of light so that when a reduction in light is detected, the sensor will regulate dynamically the electricity power to increase the light output for your pre-defined brightness level, and thus maintaining a constant level of brightness.



Note:

- This function is only enabled when the Customer Power Level is set at less than 100%. The reduced power percentage will be used to later regulate the brightness when the Constant Brightness function is enabled.

Background

User can use this function to specify the image displayed on the blank screen when there is no input signal. The selectable items are Logo, Black and Blue, the default setting is Logo.

Startup Logo

Press ENTER button, and use the ◀ or ▶ button to turn on / off the Startup Logo.

Infrared Remote

Remote Sensor: The default is On. However, there are three conditions that will be suggested to turn off "Remote Sensor"; the possible condition is that if the user uses wired control, he can set this function to Off, or that if the projector IR location is exposed to the bright sunlight or fluorescence, or that projector control is not controlled by remote. If the user would like to reset to On, user can only set by OSD panel or RS-232.

ID Control Enable: This option allows you to enable the projector ID control function. You can turn on this function and give an ID number for the projector, then set the same ID number for the remote control to match the projector ID. After ID code is set, you can control the specified projector by the remote control.

Control ID Number: Select the option then press the ◀ or ▶ button to set the ID number of the projector, this option is selectable when Projector ID Control is enabled.

Trigger 1, 2

The projector provides a set of trigger output ports for connection to a screen. The user can connect the triggers between the screen and projector by a cable. Once the projector is powered on, the screen would be automatically turned on as well. There is a 2-3 second delay to activate this function. The selectable aspect ratios are as follows:

Off: Turn off screen trigger.

Screen: Outputs 12V of power on Trigger for whichever aspect ratio.

5:4: Outputs 12V of power on Trigger when Aspect Ratio is set to 5:4.

4:3: Outputs 12V of power on Trigger when Aspect Ratio is set to 4:3.

16:10: Outputs 12V of power on Trigger when Aspect Ratio is set to 16:10.

16:9: Outputs 12V of power on Trigger when Aspect Ratio is set to 16:9.

1.88: Outputs 12V of power on Trigger when Aspect Ratio is set to 1.88.

2.35: Outputs 12V of power on Trigger when Aspect Ratio is set to 2.35.

Letterbox: Outputs 12V of power on Trigger when Aspect Ratio is set to Letterbox.

Source: Outputs 12V of power on Trigger when Aspect Ratio is set to Source.

Native: Outputs 12V of power on Trigger when Aspect Ratio is set to Native.

OSD Settings

Menu Position: Adjust menu position through this function. The available position options are at Top-Left, Top-Right, Bottom-Left, Bottom-Right and center of the screen.

Menu Transparency: Changes the transparency of OSD Menu. The background color of the OSD can be adjusted from a darker solid color to a lighter transparent color.

Time Out: Set up the timer to exit OSD menu. The available options are Always On, 10 Seconds, 30 Seconds and 60 Seconds.

Message Box: This function allows you to disable the pop-up message on the bottom-right of the screen.

Control Panel Lock: Avoids someone accidentally pressing the control panel on the machine, causing the projector's various settings to be changed incorrectly. Refer to " page 28 ,Using the Control Panel Lock " for detail message.

Security Lock: Avoids unauthorized personnel to operate the projector. Refer to " page 29 ,Using the Security Lock " for detail message.

Image Latency

This function allows you to set image latency. Note that normally the image latency should be set to Normal for best picture quality.

Normal: Set image latency to 2 frames.

Fast: Set image latency to less than 1.5 frames.

OSD Menu – SERVICE

INPUT	PICTURE	ALIGNMENT	CONTROL	SERVICE
Model				DU9900Z
Serial Number				WDU80905410010
Software Version 1				ME05-SE05-FE03
Software Version 2				LD07-06-R04.04-3092
Control / Remote ID				X / 26
Active Source				HDMI 2
Signal Format				1920x1200@60Hz RB
H/V Refresh Rate				74.038 KHz / 59.95 Hz
Pixel Clock				154.000 MHz
Light Time				00059 HRS
System Status				↔/▶
Thermal Status				↔/▶
Factory Reset				↔/▶

EXIT = Back | Item Adjust ◀▶ | Scroll ▲▼

Model

Display the project model name.

Serial Number

Display the serial number of the projector.

Software Version 1 / Software Version 2

Display the software version in the projector.

Control/Remote ID

Display current projector ID and remote control ID number.

Active Source

Display the current input source information.

Signal Format

Display current input source format.

H/V Refresh Rate

Display horizontal and vertical refresh rates of the current picture.

Pixel Clock

Displays the pixel clock of the current input signal.

Light Time

Displays the accumulated time which the light source of the projector is used.

System Status

Display the status of system.

Thermal Status

Displays the current status of the thermal management components.

Factory Reset

Use this function to reset all the settings to factory default; light time.

Product Specification

Display Type	Single Chip 0.96" DLP Technology	
**Brightness	20,000ANSI, 22,000 ISO Lumens	
Native Resolution	WUXGA (1920 x 1200)	
Maximum Resolution	WUXGA (1920 x 1200)@60Hz (Reduced Blanking)	
Dynamic Contrast Ratio	3,000,000:1	
Illumination Type	Laser Phosphor	
Throw Ratio*	1.5 – 2.0:1	
Image Size (Diagonal)*	40" - 500"	
Projection Distance*	1.24 - 21.8m (4.06ft to 71.52ft)	
F Number	F = 2.17 -2.65	
Zoom Ratio*	1.33x	
Aspect Ratio	16:10	
Offset	Motorized Lens Shift	
Keystone Correction	Horizontal $\pm 60^\circ$, Vertical $\pm 40^\circ$ (adjustable range of single direction)	
Horizontal Frequency	15, 31 – 91.4kHz	
Vertical Scan Rate	24 - 30Hz, 47 - 120Hz	
Edge Blending	Yes (Built-In)	
Warping	Yes (Built-In)	
3D Functionality	Yes (DLP® Link™, HDMI v1.4 (Blu-ray, Side by Side, Frame Packing, Top and Bottom))	
Adjustable Lens Shift Range	Vertical: $\pm 50\%$, Horizontal: $\pm 15\%$	
I/O Connection Ports	HDMI v1.4b (x2), DisplayPort, DVI-D, Component (5 BNC), VGA-In, 3G-SDI-In/Out, RS-232, VGA-Out, 3D-Sync In/Out, 12v Trigger(x2), Wired Remote, HDBaseT™/LAN (Shared)	
Projection Method	Table Top, Ceiling Mount (Front or Rear), Free-Tilt , Portrait	
Security Solutions	Kensington® Security Slot, Security Bar	
Dimensions (WxDxH)	743 x 530 x 248mm (29.2" x 20.8" x 9.7")	
Weight	49kg \pm 1kg (108.0lbs \pm 2.2lbs)	
Noise Level	48dB (Normal Mode) / 46dB (Eco Mode)	
Power Supply	AC 100V~130V, 50/60Hz / AC 200V~240V, 50/60Hz	
**Power Consumption	Normal Mode	1150W@110Vac, 1950W@220Vac
	Standby Power On (LAN)	Less than 6W
	Standby Power Off (Eco)	Less than 0.5W
Operating Conditions	At Temperature 0°C to 40°C, Relative Humidity 90% (with maximum temperature of 35°C), Non-Condensation	
Storage Conditions	At Temperature -20°C to 60°C, Relative Humidity 10% to 90%, Non-Condensation	
Standard Accessories	AC Power Cord, Remote Control w/Batteries, HDMI Cable, Lens Cap	
Optional Accessories	Interchangeable Lens Options	

*Note: Standard Lens

** When the input voltage is 110V, the current supplied by the power supply does not provide the current required to run the projector at full power. In this case, the projector will automatically reduce the light source power to 65%, and the projector light output will also be reduced to about 65% of the nominal brightness accordingly to ensure that the projector can operate normally.

Supported Signal Input Timing

Signal Format	Resolution	H Freq. (KHz)	Frame Rate (Hz)	PCLK (MHz)	DisplayPort	HDMI / HDBaseT				HD/SDI/3G
						RGB	YUV 8-bit	YUV 10-bit	YUV 12-bit	
PC	640x480	31.469	59.94	25.175	○	○				
	640x480	37.500	74.99	31.500	○	○				
	640x480	43.269	85	36.000	○	○				
	800x600	37.879	60.32	40.000	○	○				
	800x600	46.875	75	49.500	○	○				
	800x600	53.674	85.06	56.250	○	○				
	848x480	23.674	47.95	25.000	○	○				
	848x480	31.020	60	33.750	○	○				
	1024x768	48.363	60	65.000	○	○				
	1024x768	56.476	70.07	75.000	○	○				
	1024x768	60.023	75	78.750	○	○				
	1024x768	68.677	85	94.500	○	○				
	1152x864	67.5	75	108.000	○	○				
	1280x720	35.531	47.95	57.987	○	○				
	1280x768	47.776	60	79.500	○	○				
	1280x768	60.289	74.89	102.250	○	○				
	1280x768	68.633	84.84	117.500	○	○				
	1280x800	49.702	60	83.500	○	○				
	1280x800	62.795	74.93	106.500	○	○				
	1280x960	60.000	60	108.000	○	○				
	1280x960	85.938	85	148.500	○	○				
	1280x1024	63.981	60.02	108.000	○	○				
	1280x1024	79.976	75.02	135.000	○	○				
	1280x1024	91.146	85.02	157.500	○	○				
	1366x768	47.712	60	85.500	○	○				
	1440x900	55.935	59.89	106.500	○	○				
	1440x900	70.635	74.98	136.750	○	○				
	1400x1050	65.317	60	121.750	○	○				
	1400x1050	82.278	74.87	156.000	○	○				
	1600x900	55.92	60	119.000	○	○				
	1600x1200	75.000	60	162.000	○	○				
	1680x1050	65.290	60	146.250	○	○				
	1920x1080	53.225	47.95	135.403	○	○				
1920x1200 RB	58.894	47.96	122.500	○	○					
1920x1200	61.816	50	158.250	○	○					
1920x1200 RB	74.038	60	154.000	○	○					
2048x1152 RB	72.000	60	162.000	○						
2560x1600 RB	98.713	59.97	268.500	○						

Signal Format	Resolution	H Freq. (KHz)	Frame Rate (Hz)	PCLK (MHz)	DisplayPort	HDMI / HDBaseT				HD/SDI/3G
						RGB	YUV 8-bit	YUV 10-bit	YUV 12-bit	
Apple Mac	640x480	35.000	66.67	30.240	○	○				
	832x624	49.720	74.55	57.280	○	○				
	1024x768	60.241	74.93	80.000	○	○				
	1152x870	68.861	75.06	100.000	○	○				
SDTV	480i	15.734	59.94	13.500						○
	576i	15.625	50	13.500						○
	1440x480i	31.468	60	27.000		○	○	○	○	
	1440x576i	31.250	50	27.000		○	○	○	○	
EDTV	480p	31.469	59.94	27.000	○	○	○	○	○	
	576p	31.250	50	27.000	○	○	○	○	○	
HDTV	1035i	33.750	60	74.250		○	○	○	○	○
	1080i	28.125	50	74.250	○	○	○	○	○	○
	1080i	33.716	59.94	74.176	○	○	○	○	○	○
	1080i	33.750	60	74.250	○	○	○	○	○	○
	720p	37.500	50	74.250	○	○	○	○	○	○
	720p	44.955	59.94	74.176	○	○	○	○	○	○
	720p	45.000	60	74.250	○	○	○	○	○	○
	1080p	26.973	23.98	74.176	○	○	○	○	○	○
	1080p	27.000	24	74.250	○	○	○	○	○	○
	1080p	28.125	25	74.250	○	○	○	○	○	○
	1080p	33.716	29.97	74.176	○	○	○	○	○	○
	1080p	33.750	30	74.250	○	○	○	○	○	○
	1080p	56.250	50	148.500	○	○	○	○	○	○
	1080p	67.433	59.94	148.352	○	○	○	○	○	○
1080p	67.500	60	148.500	○	○	○	○	○	○	
PsF formats	1080sf	27	24	74.250						○
	1080sf	28.125	25	74.250						○
	1080sf	33.75	30	74.250						○
HD-SDI	720p24	18	24	74.250						○
	720p25	18.75	25	74.250						○
	720p30	22.5	30	74.250						○

Supported 3D Signal

Standard		Resolution	V-Freq (Hz)	V-Total	H-Freq (kHz)	HDMI1/2 (*1)	DisplayPort (*2)	HB DisplayPort (*3)	Remarks	Output Display Frame Rate
720p50	Frame Packing	1280x720	50.00	1470	37.50	○			*5	100
720p59	Frame Packing	1280x720	59.94	1470	44.96	○			*5	120
720p60	Frame Packing	1280x720	60.00	1470	45.00	○			*5	120
720p50	Top-and-Bottom	1280x720	50.00	750	37.50	○	○		*5	100
720p59	Top-and-Bottom	1280x720	59.94	750	44.96	○	○		*5	120
720p60	Top-and-Bottom	1280x720	60.00	750	45.00	○	○		*5	120
1080p23	Frame Packing	1920x1080	23.98	2205	26.97	○			*6	144
1080p24	Frame Packing	1920x1080	24.00	2205	27.00	○			*6	144
1080i50	Side-by-Side (Half)	1920x1080	50.00	1125	56.25	○	○		*5	100
1080i59	Side-by-Side (Half)	1920x1080	59.94	1125	67.43	○	○		*5	120
1080i60	Side-by-Side (Half)	1920x1080	60.00	1125	67.50	○	○		*5	120
1080p50	Side-by-Side (Half)	1920x1080	50.00	1125	56.25	○	○		*5	100
1080p59	Side-by-Side (Half)	1920x1080	59.94	1125	67.43	○	○		*5	120
1080p60	Side-by-Side (Half)	1920x1080	60.00	1125	67.50	○	○		*5	120
1080p50	Top-and-Bottom	1920x1080	50.00	1125	56.25	○	○		*5	100
1080p59	Top-and-Bottom	1920x1080	59.94	1125	67.43	○	○		*5	120
1080p60	Top-and-Bottom	1920x1080	60.00	1125	67.50	○	○		*5	100
1080p50	Frame Sequential	1920x1080	50.00	1125	56.25	○	○			100
1080p59	Frame Sequential	1920x1080	59.94	1125	67.43	○	○			120
1080p60	Frame Sequential	1920x1080	60.00	1125	67.50	○	○			120
1080p100	Frame Sequential	1920x1080	100.00	1125	112.50			○	*4, *5	100
1080p120	Frame Sequential	1920x1080	120.00	1125	135.00			○	*4, *5	120
WUXGA_100_RB	Frame Sequential	1920x1200	100.00	1258	125.72			○	*4, *5	100
WUXGA_120_RB	Frame Sequential	1920x1200	120.00	1271	152.40			○	*4, *5	120
1080p23	Dual Channel	1920x1080	23.98	1125	26.97				*6	144
1080p24	Dual Channel	1920x1080	24.00	1125	27.00				*6	144
1080p25	Dual Channel	1920x1080	25.00	1125	28.13				*5	100
1080p30	Dual Channel	1920x1080	30.00	1125	33.75				*5	120
1080p50	Dual Channel	1920x1080	50.00	1125	56.25				*5	100
1080p59	Dual Channel	1920x1080	59.94	1125	67.43				*5	120
1080p60	Dual Channel	1920x1080	60.00	1125	67.50				*5	120
WUXGA_60_RB	Dual Channel	1920x1200	60.00	1235	74.04				*5	120

Note:

- *1: Based on IT6802 chip specification
- *2: Based on IT6535 chip specification
- *3: Disable PIP function in this situation
- *4: 8-bit / color
- *5: Frame drop at scaler and frame doubling at formatter
- *6: Output display frame rate up to 144Hz for 24Hz 3D input

Configurations of Terminals

DVI-D Terminal

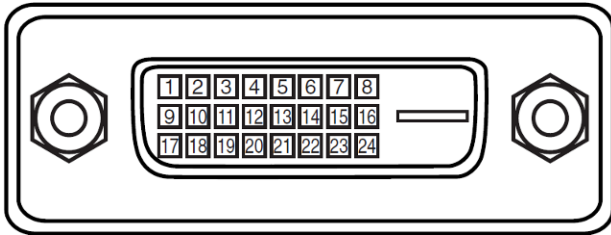

1	T.M.D.S. Data 2- Input	13	N.C
2	T.M.D.S. Data 2+ Input	14	P5V
3	Ground	15	Ground
4	N.C	16	HPD
5	N.C	17	T.M.D.S. Data 0- Input
6	SCL	18	T.M.D.S. Data 0+ Input
7	SDA	19	Ground
8	N.C	20	N.C
9	T.M.D.S. Data 1- Input	21	N.C
10	T.M.D.S. Data 1+ Input	22	Ground
11	Ground	23	T.M.D.S. Clock+ Input
12	N.C	24	T.M.D.S. Clock- Input

VGA Terminal (D-sub 15 pin)

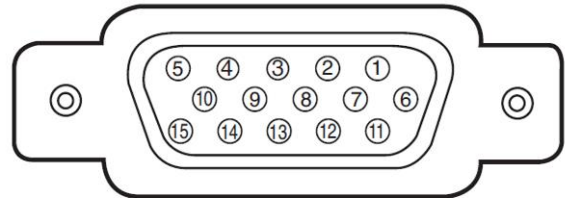

Input

1	Red Input	9	P5V
2	Green Input	10	GND
3	Blue Input	11	GND
4	N.C	12	VGA_SDA
5	N.C	13	H-Sync
6	GND	14	V-Sync
7	GND	15	VGA_SCL
8	GND	16	GND

HDMI(19 pin Type A)

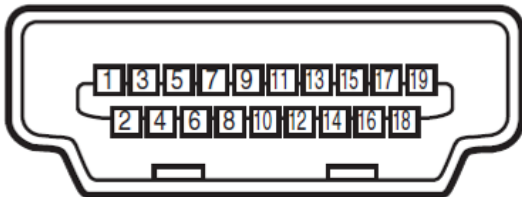

1	T.M.D.S. Data 2+ Input	11	Ground
2	Ground	12	T.M.D.S. Clock C- Input
3	T.M.D.S. Data 2- Input	13	CEC
4	T.M.D.S. Data 1+ Input	14	N.C
5	Ground	15	SCL
6	T.M.D.S. Data 1- Input	16	SDA
7	T.M.D.S. Data 0+ Input	17	Ground
8	Ground	18	P5V
9	T.M.D.S. Data 0- Input	19	HPD
10	T.M.D.S. Clock C+ Input		

Serial Control Terminal (RS-232, D-sub 9 pin)

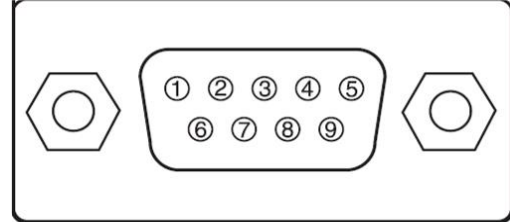

	Serial
1	N.C
2	RXD
3	TXD
4	N.C
5	Ground
6	N.C
7	Short with pin8
8	Short with pin7
9	N.C

Screen Trigger

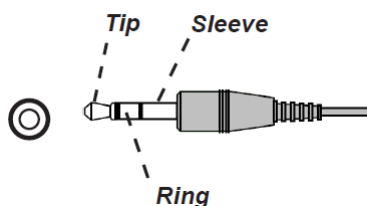

1	Tip	VCC(12V)
2	Sleeve-	Ground
3	Ring	Signal

Wired Remote

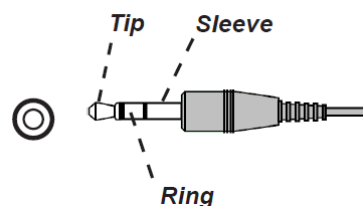

1	Tip	VCC(3.3V)
2	Sleeve-	Ground
3	Ring	Signal

HDBaseT/LAN Terminal (RJ-45)

3D Sync Out

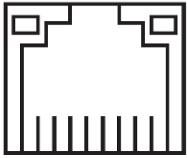

87654321	
1	TX+
2	TX-
3	TXC
4	Ground
5	Ground
6	RXC
7	RX+
8	RX-

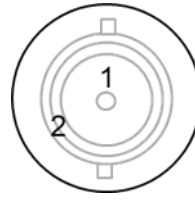

1	Signal
2	Ground

DU9900Z Lens Series

Five types of optional electric lenses are available for the projector and are listed in the below table. Contact an authorized Vivitek dealer for additional details.

Part Number	Lens Name	F Number	Focal Length	Zoom Ratio	Screen Size	Throw Ratio
D98-0912	Extreme Ultra Wide Angle Lens	2.2 - 2.53	19.34 – 25.76mm	1.33:1	50" - 500"	0.9 - 1.2:1
D98-1215	Short Throw Lens	2.18 - 2.66	25.69 - 33.22mm	1.3:1	40" - 500"	1.2 - 1.56:1
D98-1520	Standard Lens	2.17 - 2.65	31.9 - 42.2mm	1.33:1	40" - 500"	1.5 - 2.0:1
D98-2040	Longer Zoom Lens	2.17 - 2.64	42.6 - 84.8mm	2.0:1	40" - 500"	2.0 - 4.0:1
D98-4070	Ultra Long Zoom Lens	2.2 - 2.57	83.9 - 146.85mm	1.75:1	50" - 500"	4.0 - 7.0:1

Product Dimensions

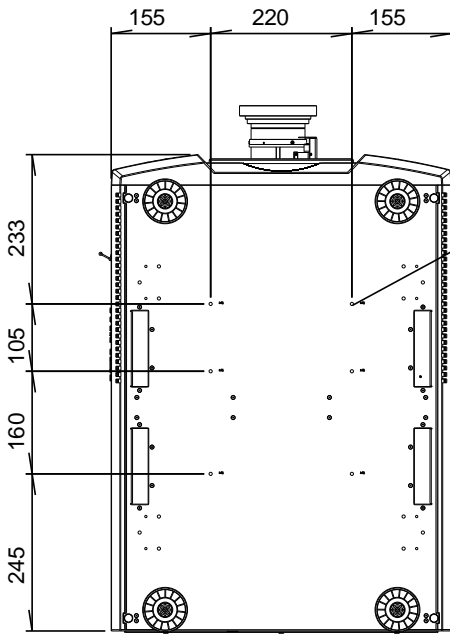
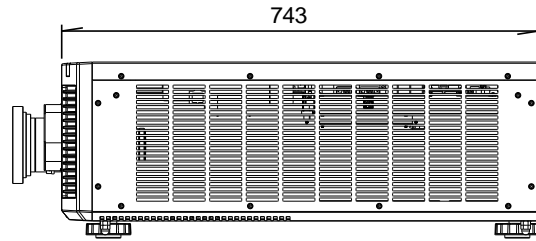
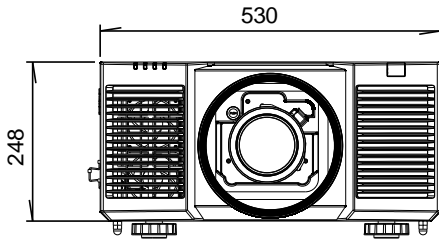

6 mounting holes
M6*1, Max. length
L=16

LED Indication

Several indicators messages are used to display the current projector status or alert the abnormal message.

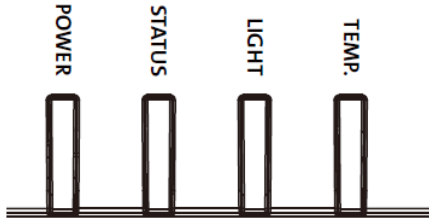

POWER LED Indicator

LED Color and Status	Pattern Sequence	Condition Description
Off (No color)	Grey grid	AC Power is off
GREEN, continuous flashing.	Green grid	Projector is powering up
ORANGE, continuous flashing.	Orange grid	Projector is cooling down to standby mode
RED, continuous flashing.	Red grid	From AC on and prepare goes into network standby
RED, solid on.	Solid red grid	Standby Mode: Power Saving without network control capability
ORANGE, solid on.	Solid orange grid	Standby Mode: with Network control capability.
GREEN, solid on.	Solid green grid	Projector is power on

STATUS LED Indicator

LED Color and Status	Pattern Sequence	Condition Description
Off (No color)	Grey grid	No Error
ORANGE, repeat flash 2 times.	Orange grid	Request to re-execute the Lens Calibration process.
GREEN, repeat flash 2 times.	Green grid	Lens calibration is processing.
RED, repeat flash 1 time.	Red grid	Cover Error
RED, repeat flash 2 times.	Red grid	TEC/Color sensor Problem
RED, repeat flash 4 times.	Red grid	Fan Error
ORANGE, solid on.	Solid orange grid	Firmware Upgrade mode
RED, solid on.	Solid red grid	System Error

LIGHT LED Indicator

LED Color and Status	Pattern Sequence	Condition Description
Off (No color)	Grey grid	Light source is off.
ORANGE, solid on.	Solid orange grid	Light source be run on Forced Eco mode when high temperature.
GREEN, solid on.	Solid green grid	Light source is normal running.
GREEN, repeat flash 1 time.	Green grid	Light source is temporary off by SHUTTER ON (Closed).
RED, repeat flash 1 time.	Red grid	Light source can't be ignited when warm up phase.
RED, repeat flash 2 times.	Red grid	Light source be extinguished during normal operation.

TEMP LED Indicator

LED Color and Status	Pattern Sequence	Condition Description
Off (No color)	Grey grid	No Error
RED, continuous flashing.	Red grid	Temperature Error

Common Problems and Solutions

These guidelines provide tips to deal with problems you may encounter while using the projector. If the problem remains unsolved, contact your dealer for assistance.

Often the problem is something as simple as a loose connection. Check the following before proceeding to the problem-specific solutions.

- Use some other electrical device to confirm that the electrical outlet is working.
- Ensure the projector is turned on.
- Ensure all connections are securely attached.
- Ensure the attached device is turned on.
- Ensure a connected PC is not in suspending mode.
- Ensure a connected notebook computer is configured for an external display. (This is usually done by pressing an Fn-key combination on the notebook.)

Tips for Troubleshooting

- In each problem-specific section, try the steps in the order suggested. This may help you to solve the problem more quickly.
- Try to pinpoint the problem to avoid replacing non-defective parts.
- For example, if you replace batteries and the problem remains, put the original batteries back and go to the next step.
- Keep a record of the steps you take when troubleshooting. The information may be useful when calling for technical support or for passing on to service personnel.

Image Problems

Problem: No image appears on the screen

1. Verify the settings on your notebook or desktop PC.
2. Turn off all equipment and power up again in the correct order.
3. Check if shutter is enabled.

Problem: The image is blurred

1. Adjust the Focus on the projector.
3. Performance Auto Sync on the remote control or projector.
4. Ensure the projection distance is within the specified range.
5. Check that if the projection lens is clean.

Problem: The image is wider at the top or bottom (trapezoid effect)

1. Position the projector so it is as perpendicular to the screen as possible.
2. Use the Keystone function to correct the problem.

Problem: The image is reversed or upside down

Check the Projection Mode setting on the CONTROL->Projection Mode menu.

Problem: The image is streaked

1. Set the Total dots (H Total) and VGA Setup settings on the INPUT menu of the OSD to the default settings.
2. To ensure the problem is not caused by a connected PC's video card, connect to another computer.

Problem: The image is flat with no contrast

1. Adjust the Contrast setting on the PICTURE menu of the OSD.
2. Adjust the Brightness setting on the PICTURE menu of the OSD.

Problem: The color of the projected image does not match the source image.

Adjust the Color temperature and Gamma settings on the PICTURE menu of the OSD.

Projection Problems

Problem: There is no light from the projector

1. Check that the power cable is securely connected.
2. Ensure the power source is good by testing with another electrical device.
3. Restart the projector in the correct order and check that the Power LED is green.
4. Check if Blank or Shutter function is enabled

Remote Control Problems

Problem: The projector does not respond to the remote control.

1. Direct the remote control towards remote sensor on the projector.
2. Ensure the path between remote and sensor is not obstructed.
3. Check the remote sensor on OSD is turned on.
4. Ensure remote control wire is not plugged in the projector.
5. Turn off any fluorescent lights in the room.
6. Check the battery polarity.
7. Replace the batteries.
8. Turn off other Infrared-enabled devices in the vicinity.
9. Have the remote control serviced.
10. Ensure that the remote control code conforms to the projector's code if universal remote control is used.
11. Check if Projector ID control is enabled and the ID number is correct.

Projection Lens Problems

Problem: The Zoom or Focus adjustment cannot work.

1. Check if the lens is installed properly, improper lens installation may cause to lens cannot work normally. Please follow the lens installation procedure to check again.
2. Check if Lens Lock function is enabled, locking the lens will disable all of lens adjustment functions.
3. Perform Center Lens function to calibrate the Lens again.
4. Replace the other lens to check the problem if the lens is available.
5. Contact with service center for the details.

Remote communication Problems

Problem: The projector does not respond to Ethernet control

1. Make sure Network Standby is turned on, the communication path is interrupted if it's turned off(less 0.5W)
2. Check the network configuration in your laptop and projector; refer to Remote Communication manual for more information.

Having the Projector Serviced

If you are unable to solve the problem, you should have the projector serviced. Pack the projector in the original carton. Include a description of the problem and a checklist of the steps you took when trying to fix the problem. The information may be useful to the service personnel.

About the Vivitek Support

If you cannot find solutions from this user guideline, please contact us using the contact information below:

Europe, Middle East and Africa

Vivitek Service & Support
Zandsteen 15
2132 MZ Hoofddorp
The Netherlands
Tel: +31-(0)-20-721-9318
Email: support@vivitek.eu
URL: <https://www.vivitek.eu/support/contact-support>

North America

Vivitek Service Center
15700 Don Julian Road, Suite B
City of Industry, CA. 91745
U.S.A
Tel: 855-885-2378 (Toll-Free)
Email: T.services1@vivitekcorp.com
URL: www.vivitekusa.com

Asia and Taiwan

Vivitek Service Center
16 Tungyuan Rd., Chungli Industrial Zone,
Taoyuan City 320023, Taiwan
Tel: 886-3-4526107
Tel: 0800-042-100 (Toll-Free)
Email: sv-Service.VVK.Asia@vivitek.com.tw
URL: www.vivitek.com.tw

中国/China

Vivitek客服中心
上海市浦东新区华东路1675号1幢1层、7-8层
邮政编码: 201209
400客服热线: 400 888 3526
公司电话: 021-58360088
客服邮箱: service@vivitek.com.cn
官方网站: www.vivitek.com.cn